

Quick Start

1 Turn on the detector



2 Press NOISE CANCEL

After 30 seconds electrical interference will be reduced



3 Go Detecting!

Explorer SE

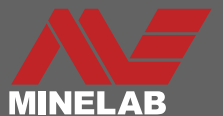

Congratulations on Purchasing Your

1

Explorer SE

Metal detecting is a fascinating and rewarding activity enjoyed by people all over the world. By getting to know your Explorer SE you can become one of the many who find valuable coins, relics, gold and jewelry on a regular basis.

The Explorer SE is Minelab's most technologically advanced detector, incorporating the unique Full Band Spectrum (FBS) Technology.

Its sleek, sturdy design, innovative control panel, lightweight coil and comprehensive targeting options set it apart from any other detector available today.

The Explorer SE will locate valuable metal objects in a variety of ground conditions, including extreme salt conditions and sea water, wet beach sand and highly mineralized ground conditions.

This manual is designed to help both the beginner and expert treasure hunter get the best performance out of the Explorer SE.

Minelab wishes you every success in your treasure hunting!

2 Contents

Quick Start	Back Page
How Metal Detectors Work	4
The Unique Technology of the Explorer SE	5
Assembly	6
Battery Packs	10
Adjusting the Detector for Comfortable Detecting	12
Introducing the Control Panel	14
Introducing the Smartfind Detect Screen	16
Help Function	17
Turning the Detector On	18
Detecting Basics	19
A Simple Detecting Exercise	20
Detector Sounds	20
Sensitivity	22
Depth	23
Threshold	24
Full Screen Display	26
Smartfind Display	28
Digital Display	30

Discrimination Pattern	32
Changing Discrimination Patterns	33
IRON MASK - Setting the Level of Ferrous Rejection	34
All Metal - Accepting All Targets	36
Menu Structure	38
SELECT - Preset Discrimination Patterns	40
SELECT - Selecting Preset Discrimination Patterns	42
SELECT - Saving Discrimination Patterns	43
LEARN - Creating a Discrimination Pattern with a Specific Target	44
LEARN - Accepting a Target	46
LEARN - Rejecting a Target	47
LEARN - Saving Discrimination Patterns	48
EDIT - Editing Discrimination Patterns	50
EDIT - Editing Discrimination Patterns	52
EDIT - Saving Discrimination Patterns	53
RECOVERY - Enhancing Explorer SE Performance	54
CONTRAST - Adjusting LCD Brightness	55
NOISE CANCEL - Reducing Electrical Interference	56
VOLUME	58
TONE - Adjusting Audio Pitch	60
RESPONSE - Selecting the Way Targets Sound	62
SOUNDS - Tone Identification	64
Pinpointing - Locating the Target	66
Recovering the Target	68
Where Will I Find Treasure?	69
USER SETTINGS - Saving Your Preferred Settings	70
User Preferences - Range, Factory Presets Table	71
Battery Performance	72
Accessories	74
Technical Specifications	75
Detector Care and Safety	76
Troubleshooting	77
Glossary of Terms	78
Warranty	82
Service Repair Form	83

4 How Metal Detectors Work

Metal detectors create an electromagnetic (EM) field, which penetrates the ground. Because metal is conductive it causes a change in this field. The detector senses this change and sends a signal back to the control box, alerting the operator.

Metal detectors can determine the size, shape and composition of metallic objects beneath the coil. Typically, the larger the object, the easier it is to detect.

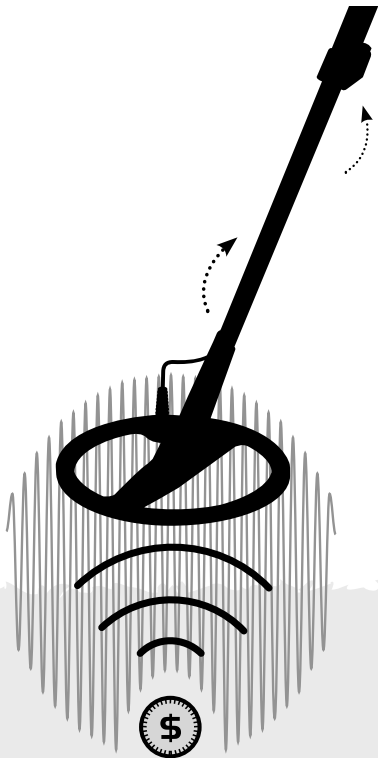

A metal detector's EM operating frequencies are measured in kilohertz (kHz).

Low frequency EM fields (e.g. 1.5 kHz) deeply penetrate the ground, but sensitivity to smaller targets is low. High frequency EM fields have a more shallow depth of penetration but sensitivity to small targets is high.

The Explorer SE's multiple frequency operation provides the advantage of both.

5 The Unique Technology of the Explorer SE

5

Full Band Spectrum (FBS)

Most detectors on the market operate on a single or dual frequency, ranging from 1 to 70 kilohertz (kHz)

Although this technology has served the industry well for years, Minelab found that a frequency that worked well in one area would often offer only marginal performance when used in another location. Ground mineralisation, trash content, and target size all had an effect on how effective a detector transmitting a single frequency would operate.

Full Band Spectrum technology combines Minelab's existing multiple frequency BBS technology with a powerful new microprocessor to give:

- > greater detecting depth
- > high sensitivity over a wide range of targets
- > less interference from electromagnetic sources
- > more accurate identification of target characteristics.

The Full Band Spectrum (FBS) circuit automatically transmits multiple frequencies simultaneously. This increased frequency range means that the signal received from the detector coil is analyzed from a wide range of responses. This allows the Explorer SE to analyse more target information so that the target identification (ID) is more accurate.

Minelab's unique FBS technology means deep, sensitive, accurate detecting.

Discrimination

Discrimination is the ability of a metal detector to identify the user's desired target (e.g. jewelry) and eliminate signals from undesirable material (e.g. nails).

The Explorer SE can be programmed in a number of ways to discriminate against unwanted targets in different types of ground.

(Discrimination Pattern, pg. 32)

Ground Compensation

The Explorer SE uses a sophisticated approach to the elimination of ground mineralisation. It uses advanced digital filtering to eliminate the influence of ground signals.

6 Assembly

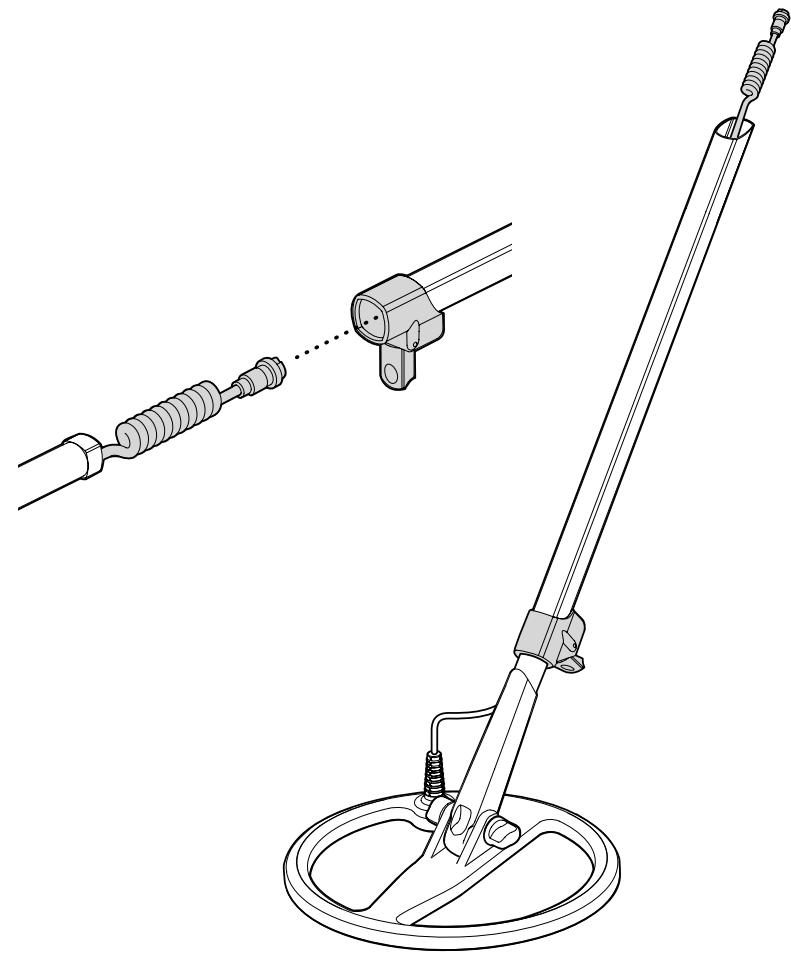
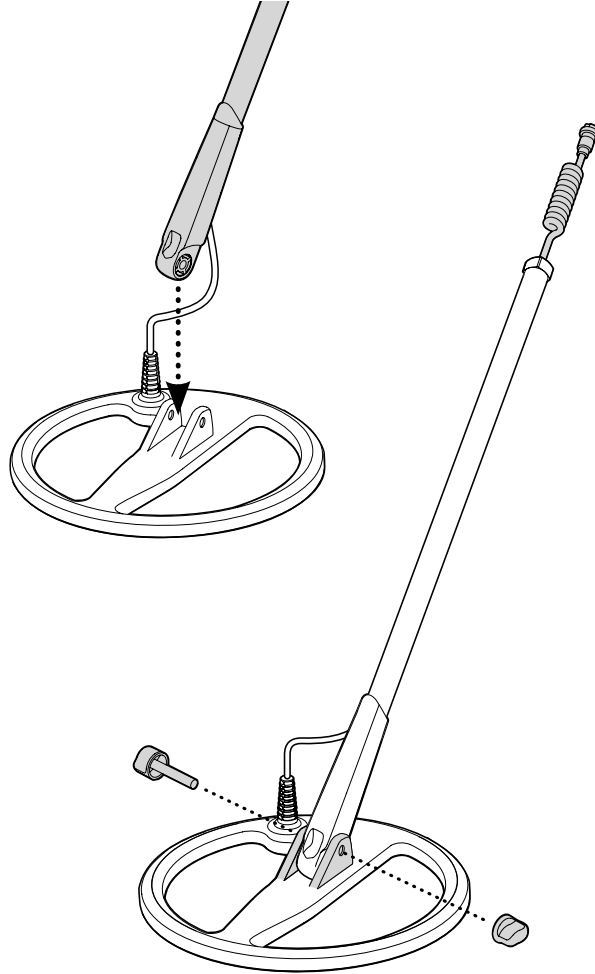
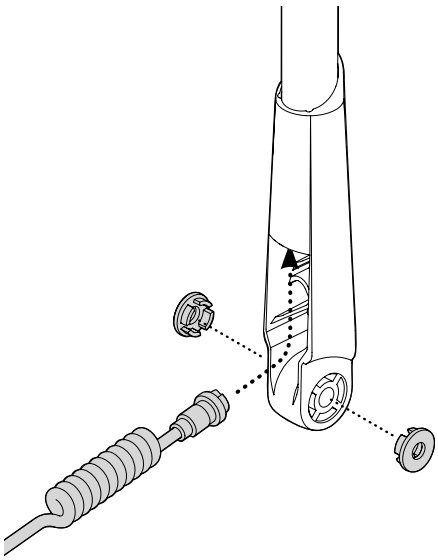

7

Attaching the Coil to the Lower Shaft:

- 1 Plug the two rubber washers into the holes on either side of the lower shaft.
- 2 Feed the coil cable up through the inside of the lower shaft.
- 3 Place the coil on a flat surface.
- 4 Slide the lower shaft into the bracket on top of the coil. Ensure that the open side of the lower shaft faces the ground.
- 5 Insert the bolt through the lower shaft and the bracket on top of the coil.
- 6 Fasten with the nut provided, being careful not to damage the thread of the nut by over-tightening. This will need to be loosened later to adjust the coil to a comfortable detecting angle.
- 7 Ensure that the coil cable appears out the top of the lower shaft.

The coil cable is directly wired into the coil and is not removable. Any attempt to remove this cable will void your warranty.

Attaching the Lower Shaft to the Upper Shaft:

- 1 Fully unlock the upper shaft camlock by releasing the lever from the shaft.
- 2 Feed the coil cable up through the inside of the upper shaft.
- 3 Ensuring that the camlock side of the shaft is facing the ground, slide the upper shaft over the lower shaft, so that the coil cable appears out the top.

8 Assembly

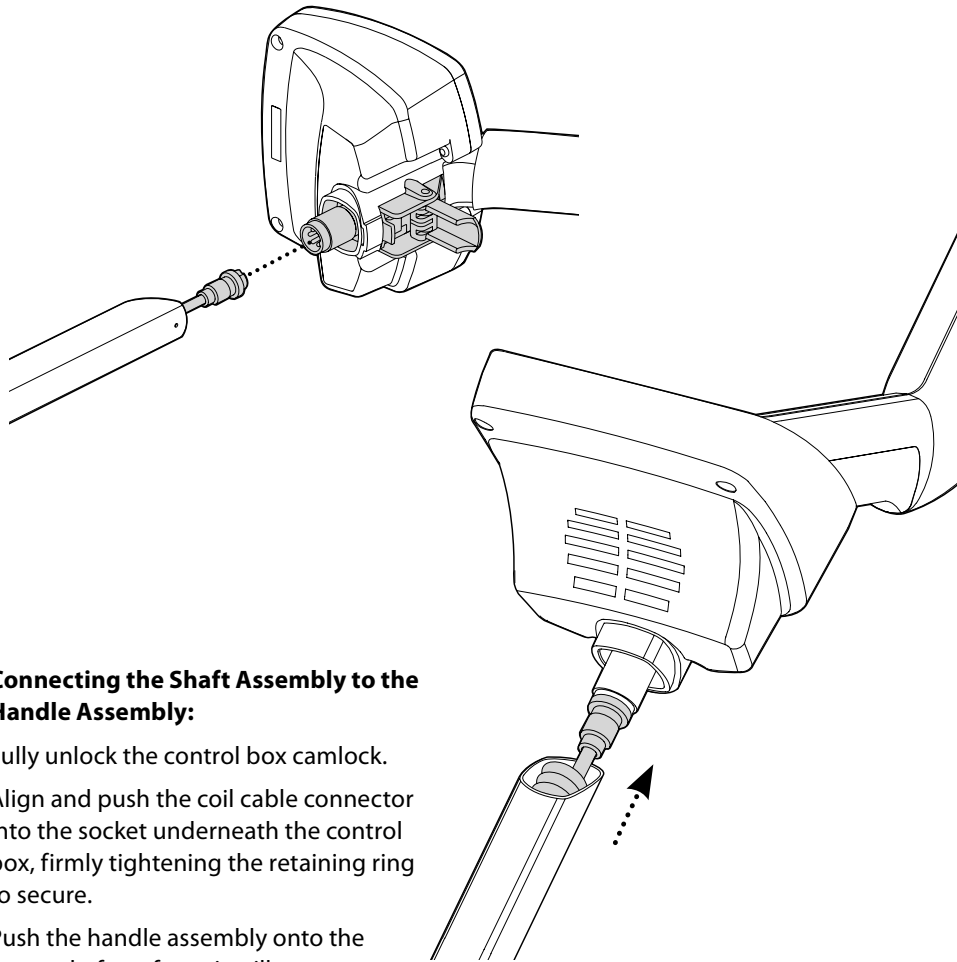

Connecting the Shaft Assembly to the Handle Assembly:

- 1 Fully unlock the control box camlock.
- 2 Align and push the coil cable connector into the socket underneath the control box, firmly tightening the retaining ring to secure.
- 3 Push the handle assembly onto the upper shaft, as far as it will go.
- 4 Fully lock the control box camlock by pushing the lever flat onto the control box.

(Adjusting the Detector for Comfortable Detecting, pg. 12)

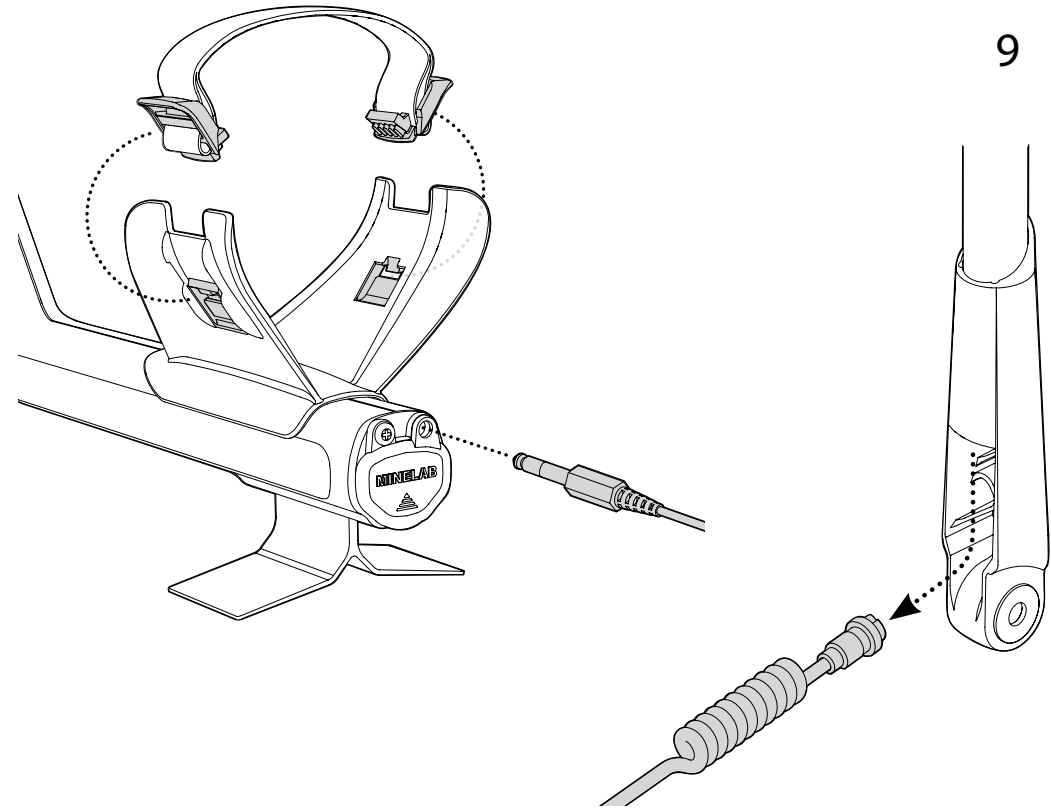

9

Attaching the Armrest Strap:

Clip both buckles onto the outer sides of the armrest.

Attaching the Headphones:

Plug the headphone jack into the headphone socket, located in the rubber seal at the top of the handle assembly.

The headphones may be plugged or unplugged at any stage during detecting.

Removing the Coil:

- 1 Follow the steps of *Attaching the lower shaft ...* and *Attaching the coil ...* (pg. 6) in reverse order to disconnect the coil from the detector.
- 2 Pull the coil cable out from inside the lower shaft.

Do not attempt to remove the shaft assembly without first disconnecting the coil cable from the control box.

A range of accessory coils are available, (Accessories, pg. 74)

10 Battery Packs

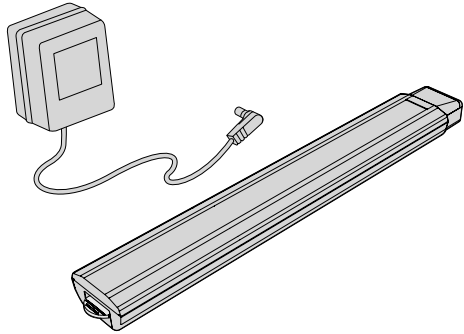

The Explorer SE has two types of battery packs:

- > One is a sealed rechargeable Nickel Metal Hydride (NiMH) battery pack. It comes with a charger which plugs into a conventional wall socket. The NiMH battery pack is supplied in the discharged condition and needs to be charged before operating the detector.
- > The other battery pack is a housing for 8 'AA' batteries.

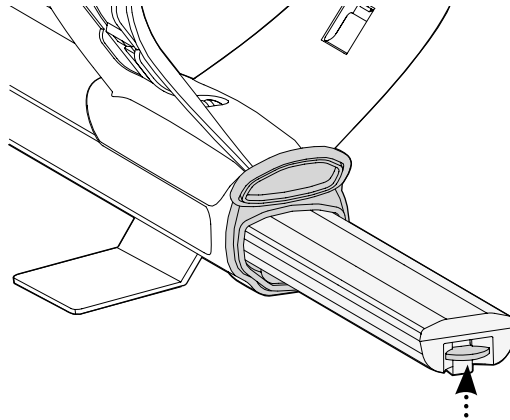

Removing the Battery Pack from the Battery Compartment:

- 1 Ensure that the detector is turned off before removing the battery pack.
- 2 Rest the detector on a flat surface.
- 3 Lift the rubber seal of the battery compartment located at the end of the handle assembly.
- 4 Raise the yellow tab to release the spring loaded battery pack.
- 5 Remove the battery pack entirely from the battery compartment.

Do not attempt to disassemble the NiMH battery pack.

If disposing of pack, do not incinerate. Contact your local authorities to enquire about disposal or recycling facilities.

The headphone jack must be unplugged before lifting the rubber seal.

Recharging NiMH Battery Pack with the Mains Charger:

- 1 Remove battery pack.
- 2 Insert the mains charger cable into the socket at the tapered end of the battery pack.
- 3 Plug the mains charger into the wall socket and turn on the switch. Leave for 18 hours to fully recharge. New batteries will reach their full capacity after several charge/ discharge cycles.
- 4 Remove the battery charger plug from the battery pack. Slide the pack back into the battery compartment until it clicks into place.

It is normal for the tip of the rechargeable battery to get warm while charging because the current regulator is mounted inside the battery pack.

The battery pack will not be damaged if left on the charger for more than 18 hours.

The battery chargers will not recharge rechargeable alkaline or NiCad batteries.

Using a non-Minelab charger with the battery pack may damage it and will void the product warranty.

Unlike Nickel Cadmium batteries, the NiMH battery pack DOES NOT have to be flattened to be recharged.

Whenever the detector has been unused for a lengthy period, recharge the battery pack to ensure full performance.

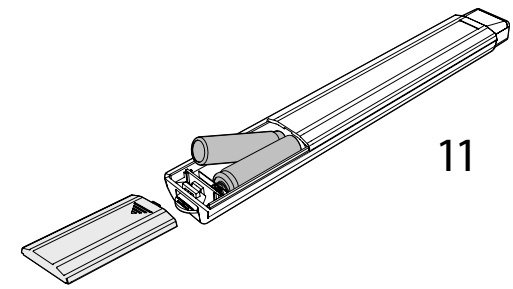

11

Replacing 'AA' Batteries.

- 1 Slide the lid of the battery pack in the direction of the arrow to open.
- 2 Place 8 x 'AA' cell alkaline batteries into the battery pack ensuring that the + and - are aligned as indicated on the label.
- 3 Slide the lid onto the battery pack until it 'clicks' into place.

High quality alkaline batteries are recommended to optimise detector usage time. Rechargeable alkaline, NiMH or NiCad batteries may be used but must be removed and recharged separately. Check fitment of rechargeable batteries prior to purchase, as some makes do not comply with standard size requirements.

Rechargeable Lithium Ion batteries will give a combined voltage above 13 V and therefore cannot be used with the Explorer SE.

Do not leave drained AA batteries in the detector as they can leak.

Placing the Battery Pack into the Battery Compartment:

- 1 Lift the rubber seal of the handle assembly.
- 2 Place the battery pack entirely into the handle assembly, until it clicks into place.
- 3 Close the rubber seal, to close the battery compartment.

12 Adjusting the Detector for Comfortable Detecting

For comfortable, long term detecting, it is important that you take the time to adjust the detector correctly.

Holding the Detector:

Thread your arm through the armrest and strap. Grasp the handle of the detector and rest your forearm in the armrest.

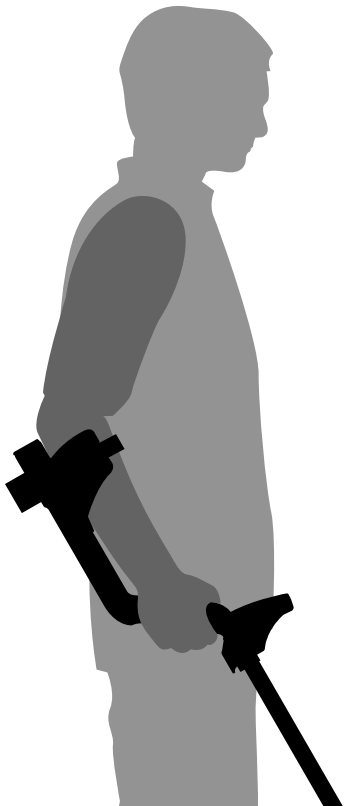

Adjusting the Position of the Armrest:

The correct position of the armrest should allow you to comfortably grip the handle. Your elbow should sit just above the back of the armrest and the detector should feel like an extension of your forearm.

- 1 Use a screwdriver or the edge of a coin to loosen the screw in the centre of the armrest (turn counter-clockwise).
- 2 While holding the detector, slide the armrest to sit just below your elbow.
- 3 Remove your arm. Tighten screw (clockwise) to lock the armrest into position.

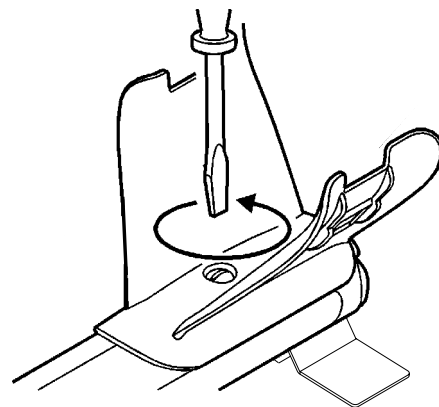

Adjusting the Armrest Strap:

- 1 Loosen strap by tilting the edge of the buckle out to release it from the armrest.
- 2 Undo the Velcro and pull the buckle outwards (towards yourself). Clip the buckle back into place and tighten the strap to secure.

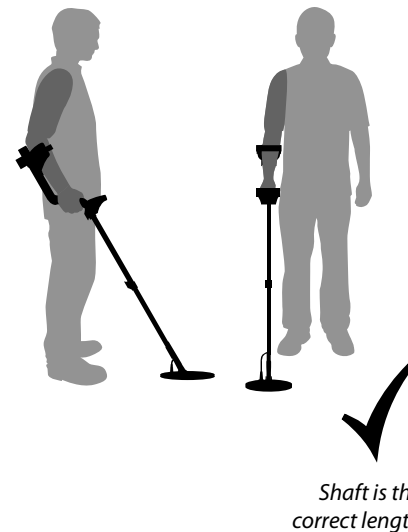

Adjusting the Length of the Shafts:

The correct length of shaft should allow you to swing the coil across the ground without any uncomfortable stretching or stooping.

If the coil is too far from your body it will be more difficult to balance and manoeuvre while detecting.

If the coil is too close to your body it may detect your digging tools or any other metal which you are carrying, causing confusing sounds.

Adjust the lower shaft to the correct length, securing the camlock to hold it in place.

For tall people, a longer lower shaft is available, (Accessories, pg. 74)

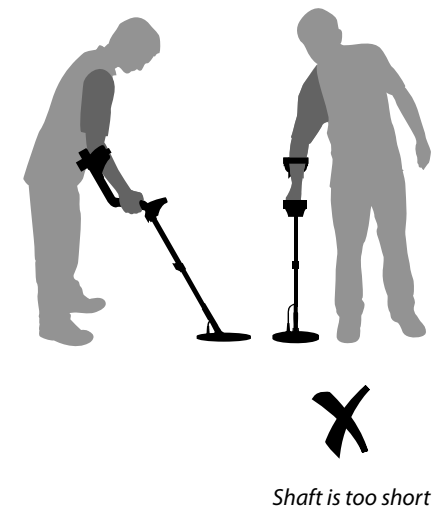

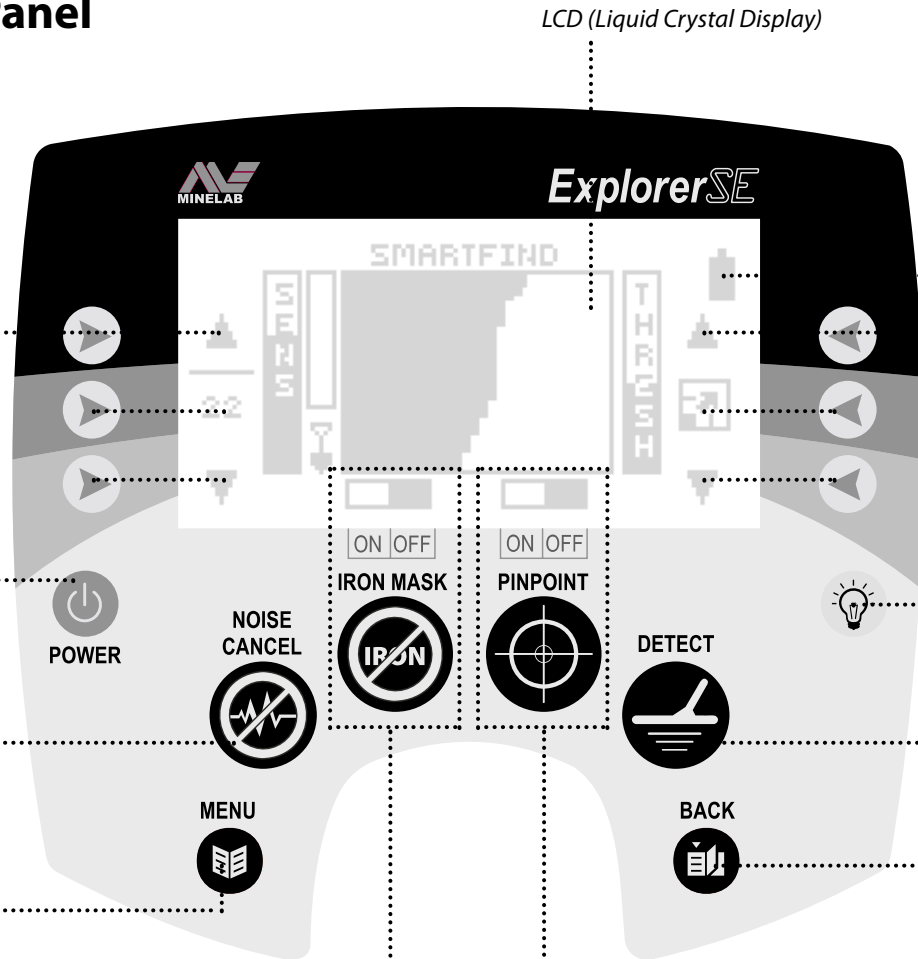

SHIFT BUTTONS
Pressing and releasing a shift button next to an icon on the display will select this option.

POWER
Turns the Explorer SE on/off and when held for 2 seconds, restores factory presets (pg. 18).

NOISE CANCEL
Automatically selects the quietest, most stable channel for detecting (pg. 56).

MENU
Brings up the MAIN MENU at any stage of detector operation. This allows access to the various settings of the detector (pg. 38).

IRON MASK
Turns Iron Mask on/off, switching between Iron Mask and using Discrimination Patterns (pg. 34).
A black bar on the display above 'ON' indicates Iron Mask is on. A black bar on the display above 'OFF' indicates Iron Mask is off.
Iron Mask is a basic Ferrous Discrimination.

LCD (Liquid Crystal Display)

BATTERY LIFE
Indicates the battery charge available (pg. 72).

SHIFT BUTTONS
Pressing and releasing a shift button next to an icon on the display will select this option.

BACKLIGHT
The backlight provides greater screen clarity in dim conditions. Even if it is switched off, the backlight illuminates for 1 second as the detector is switched on. Turning this light off will extend battery life. Contrast of the LCD can be adjusted (pg. 55).

To turn the backlight on/off:
Press the **BACKLIGHT** button.

DETECT
Returns to the detect display (Smartfind / Digital) at any stage of operation, allowing you to continue detecting. When in the detect display, pressing **DETECT** will switch between Smartfind and Digital (pg. 31).

PINPOINT
Turns Pinpoint on / off (pg. 66).
A black and flashing bar on the LCD above 'ON' indicates Pinpoint is on. A black bar on the LCD above 'OFF' indicates Pinpoint is off.
Pinpoint assists in locating the exact position of a target prior to recovery.

BACK
'Retraces' your steps back through the displays. This is useful to alter the last adjusted setting. The **BACK** button will retrace the last 3 steps (pg. 38).

16 Introducing the Smartfind™ Detect Screen

When you first turn on the Explorer SE, the Smartfind display will appear and you are able to begin detecting.

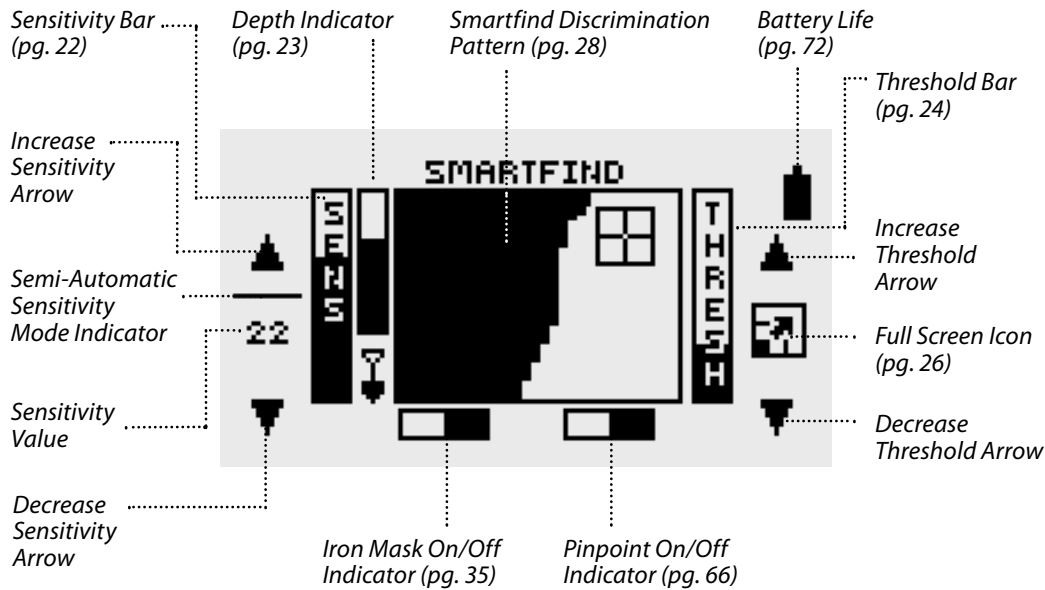

Help Function

Pressing and holding down the shift buttons next to a menu item or pressing and holding any other button for approximately one second will display a Help screen describing this particular function and various other menu options available.

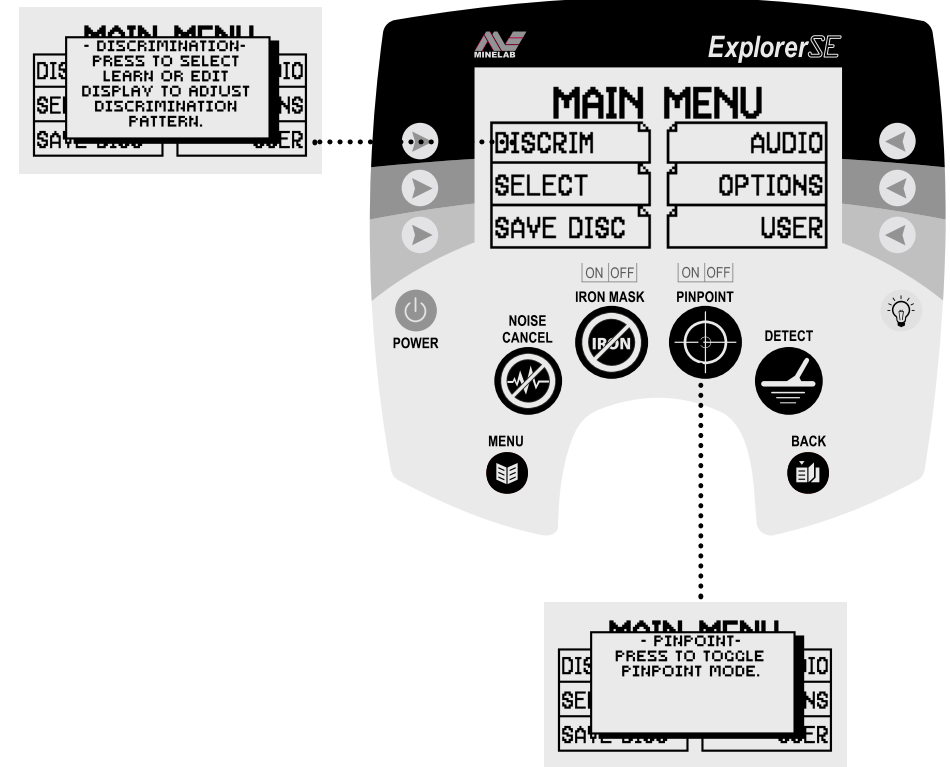

18 Turning the Detector On POWER

The **POWER** button turns the detector on and off.

The Explorer SE has factory preset settings that have been chosen to suit first-time detectorists. The detector will respond to some targets (low-ferrous metal objects such as silver coins and jewelry) and ignore others (high-ferrous objects such as nails).

It is best to only turn the detector on when outdoors, away from sources of electromagnetic disturbance such as power lines and phone towers. These sources may cause the detector to perform erratically, giving numerous false signals.

There are also many metallic objects inside a house such as nails in the floor, reinforcing in the walls, televisions and other household appliances that might overload the electronics of the detector.

To turn the detector on with Factory Preset settings:

Press and hold **POWER** for 2 seconds.

'FACTORY PRESETS' will appear briefly on the start-up display.

Turning the detector on with factory presets will restore all settings and the Discrimination Pattern.

To turn the detector on with the previous settings:

Press and release **POWER**. This will start the detector with the previous display and settings from when the detector was last used (eg. Sensitivity, Volume, etc.)

During the start up display, a four-note tune will sound.

Sometimes it is possible that a large object close to the coil will overload the detector's electronics. When this happens, the Explorer SE emits a low 'warble' which will repeat until the coil is moved away from the source of the overload.

Overloading is not harmful to the electronics of the detector.

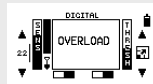

19 Detecting Basics

Targets

Buried metal objects are referred to as targets. Targets are comprised of ferrous and non-ferrous metals. High-ferrous metals are those that contain iron such as steel, nails and some types of coins. Low-ferrous metals are those that have no iron content, such as gold, silver, copper, bronze and aluminium. You may wish to find a range of both low and high ferrous targets.

Examples of common targets:

Desired high-ferrous target - Canadian coin

Undesired high-ferrous target - iron nail

Desired low-ferrous target - gold coin

Undesired low-ferrous target - pull-tab

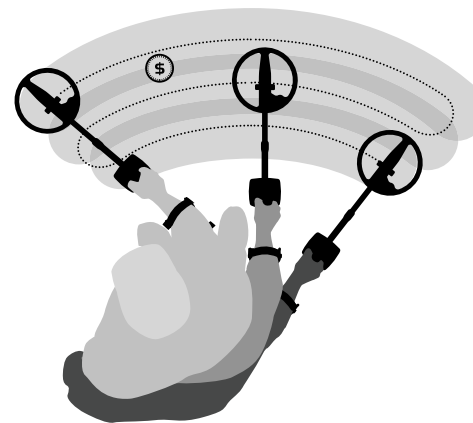

Sweeping the Coil

The Explorer SE will perform at its best when the coil is kept close and parallel to the ground at all times. This will increase detection depth and response to small objects. Avoid excessive brushing of the coil on the ground, as this may result in false signals and inaccurate Target ID's.

Practise sweeping the coil over the ground in a side-to-side motion, while walking forward slowly at the end of each sweep. Slightly overlap the previous sweep to ensure full ground coverage. An average sweep speed is four seconds from left to right to left.

A variation in coil height at the end of each swing may also cause confusing sounds and reduce detection depth.

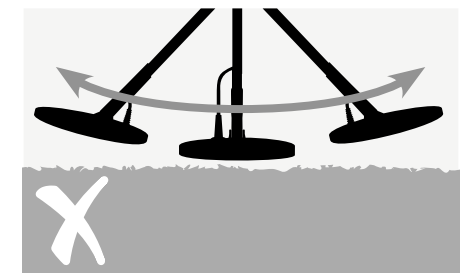
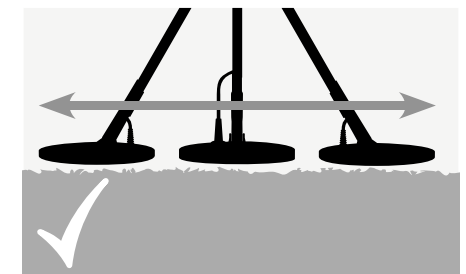

Press and hold



POWER

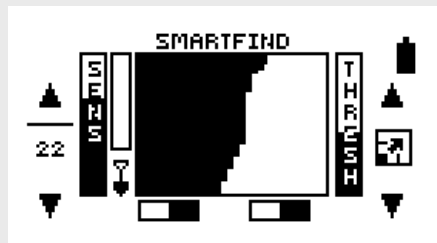

Press and Release



POWER



A Simple Detecting Exercise

Before attempting to recover real targets, it is important to understand how to interpret the audio and visual signals of the detector.

Gather a collection of different metal objects, e.g. various coins, gold and silver jewelry, a nail, pull-tab, brass button and aluminium foil.

Take the detector outdoors, away from known electro-magnetic fields or metal objects.

If you are getting signals from a clear patch of ground, there could be buried metal objects. Try finding another area.

Lay objects in a line, sufficiently spaced apart to allow the coil to pass between them, as shown.

Detector Sounds

Turn the detector on.

The **Threshold** is the background 'hum' produced by the detector. It assists in hearing very small and deep targets. It is also used to help distinguish between desired and undesired targets (blanking).

The detector may also produce **False Signals (Noise)** when not over the ground (i.e. with the coil motionless). These may not be target signals, but signals caused from the surrounding environment.

You can overcome these false signals by performing a Noise Cancel, or by reducing the Sensitivity of the detector (*Noise Cancel, pg. 56, Sensitivity, pg. 22*).

Sweep the coil across the objects, one at a time, and observe the LCD and the sounds of the detector as it detects each object.

The **Target Response** is the sound given by the detector when a target is located and not discriminated (rejected). A target that is highly conductive (e.g. a large silver coin) will generally produce a high-pitched tone and a low conductive target (e.g. foil) generally produces a lower pitched tone. Large targets or targets close to the ground surface emit a louder signal (*Sounds, pg. 64*).

When a rejected target is detected, the Threshold **'blanks'** (becomes silent) indicating that a target is located underneath the coil, but has been rejected by you. Blanking is a useful way of distinguishing between desired and undesired targets.

Take note that as the coil is passed over the nail, the Threshold 'hum' momentarily disappears, indicating that the object ignored was ferrous.

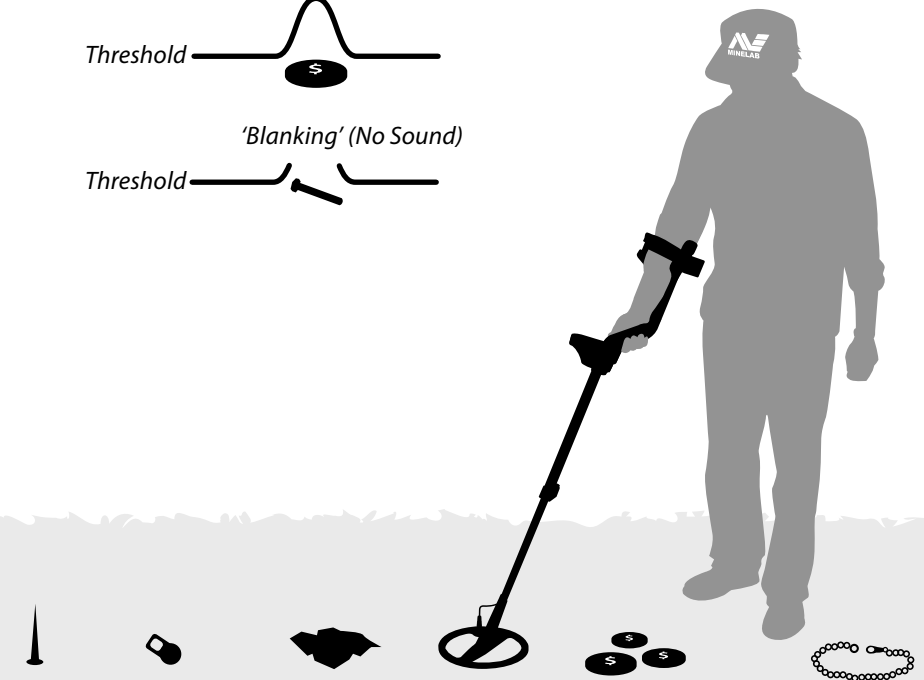
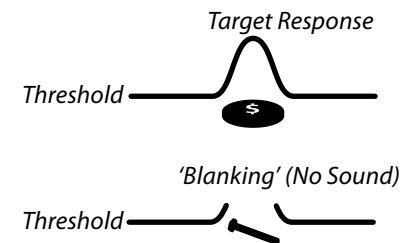

Modes: Semi-Automatic, Manual
 Range: 1 to 32
 Factory Preset: Semi-Automatic, 22

22 Sensitivity

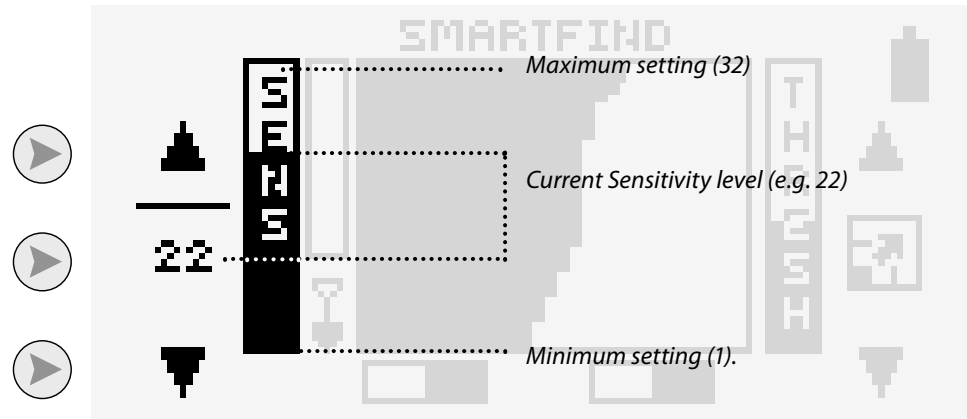

Sensitivity is the detector's level of response to its environment and to targets. Sensitivity can be only be adjusted in Smartfind and Digital Display. The Sensitivity bar is a visual indication of the Sensitivity setting.

Sensitivity can be adjusted in both the Semi-automatic mode or Manual mode.

In **Semi-Automatic Sensitivity** mode, the detector continuously monitors the environmental conditions and will adjust the Sensitivity as close as possible to your specified level of Sensitivity.

In **Manual Sensitivity** mode the adjustment allows you to control the Sensitivity directly. This is recommended for high trash areas when best results are obtained by sweeping the coil very slowly. Manual Sensitivity is suitable for the beach and very quiet/stable (unmineralised) ground, where the ground conditions do not change as often.

To adjust Sensitivity:

Press the top-left shift button to increase Sensitivity.

Press the bottom-left shift button to decrease Sensitivity.

To switch from Semi-Automatic to Manual Sensitivity:

Press the center-left shift button. A line will cycle around the number to indicate that Semi-Automatic Sensitivity is activated.

The detector with a high Sensitivity setting will detect deep targets but may respond to unwanted noise and ground signals. A high Sensitivity setting is recommended for stable conditions with low interference.

The detector with a low Sensitivity setting will ignore unwanted noise and ground signals, but may miss deep targets. A lower Sensitivity setting is preferable for very variable, 'noisy' conditions or high trash areas.



Try reducing interference before reducing Sensitivity. Press the **NOISE CANCEL** shortcut button, or manually select the least noisy channel (pg. 56).

23 Depth

23

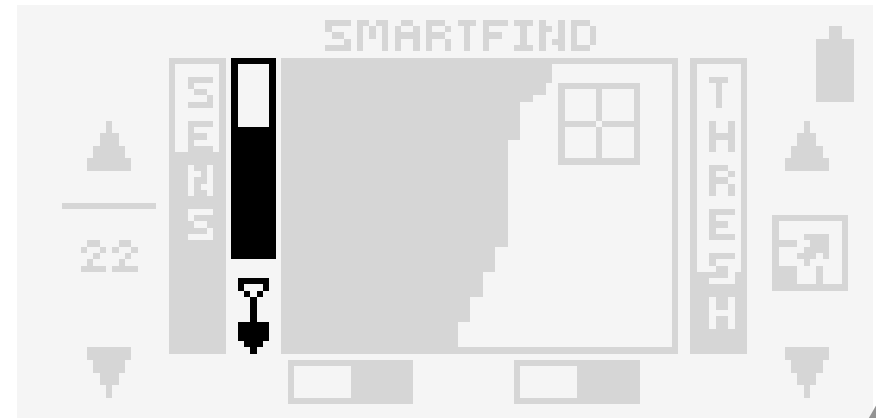

The clear portion of the depth indicator represents the approximate distance of a target below the coil.

The top of the indicator represents the position of the coil and the bottom represents 300mm (12 inches) from the coil. The bar will be clear if the target is deeper than 12 inches or its depth cannot be accurately gauged.

Try to think of the clear area of the depth indicator as the amount of soil you will have to dig to recover the target.

The depth indicator is also updated for rejected targets.

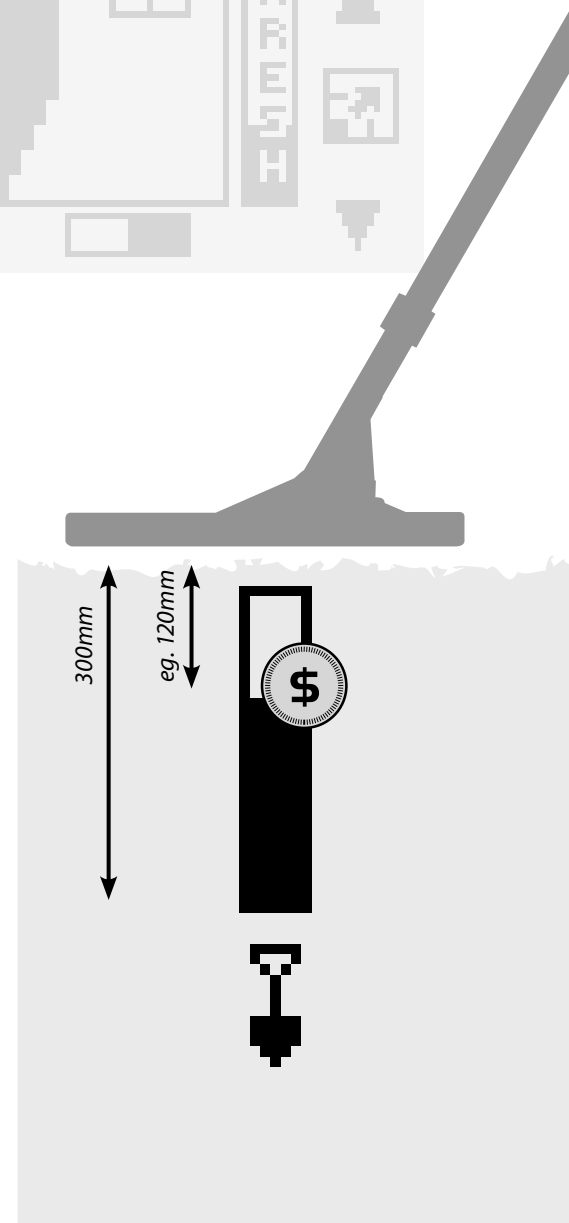

24 Threshold

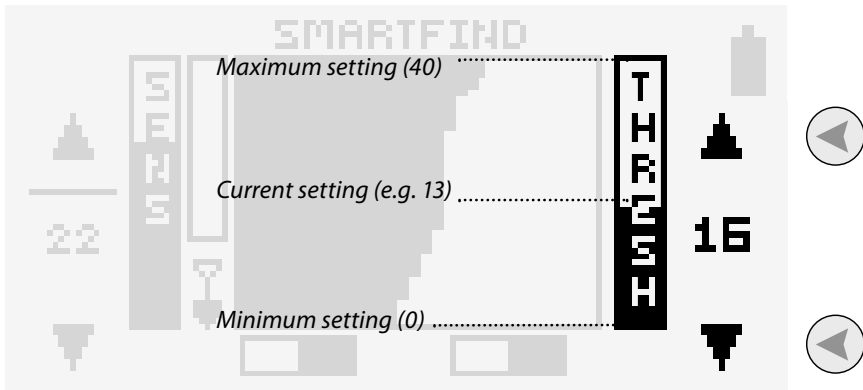

Threshold is the constant background 'hum' produced by the detector. This control sets the Threshold Volume. By setting the Threshold Volume to the correct level for your hearing, Threshold can highlight the variations in signal response which often indicate detection of a target.

The volume of the Threshold is a personal preference. The correct level will depend on your hearing and associated noise such as wind and machinery.

If the Threshold Volume is high, accepted targets will be harder to distinguish above the Threshold 'hum'. Small target responses will become difficult to discern as Threshold nears a maximum setting of 40 when there will be a persistently loud Threshold 'hum'.

If the Threshold Volume is too low, the slight variation caused by a small or deep target may not be sufficient to hear. Adjusting the level to below an audible level will ensure silent operation but could mask the audio response to small targets.

The factory preset Threshold of 16 will usually emit a constant Threshold hum and is programmed to enable an audible response to most target signals.

Since everyone's hearing is different, so Minelab suggests that you set a level of Threshold that is a very low, but still audible level for hearing.

Threshold also helps you distinguish the difference between accepted and rejected targets. When a rejected target is detected, the Threshold sound 'blanks' (becomes silent) to indicate that a rejected target is underneath the coil.

Adjusting Threshold:

Threshold is increased by pressing the top shift button and decreased by pressing the bottom shift button on the right side of the control panel.

A number corresponding to the Threshold level will appear temporarily between the two adjustment arrows.

Try experimenting with known targets to assist in setting Threshold.

The Threshold may need to be adjusted when connecting and disconnecting the headphones.

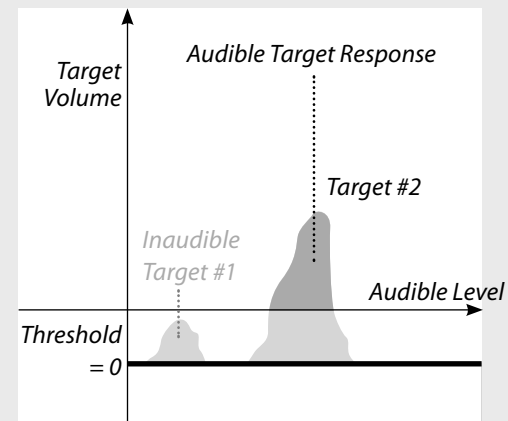

If the Threshold is set to 0, small target signals will not produce a signal big enough to go above the Audible Level.

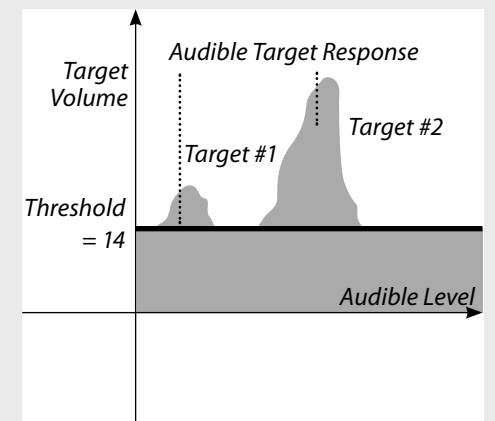

If the Threshold is set to a positive value, the detector will produce target signals and a Threshold sound.

26 Full Screen Display

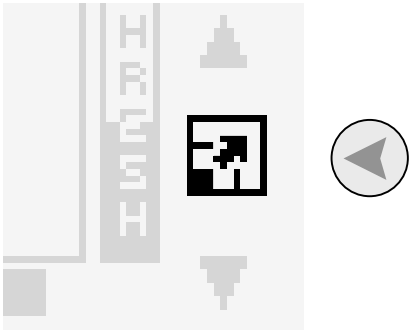

The Smartfind or Digital display may be enlarged during detecting. The Full Screen Display enlarges the Discrimination Pattern details and removes the display border and other screen elements.

The detection results information will be cleared as you switch between Normal to Full Screen, until a new detection is made.

To switch between Normal and Full Screen:

Press the shift button next to the full screen icon at the right of the control panel.

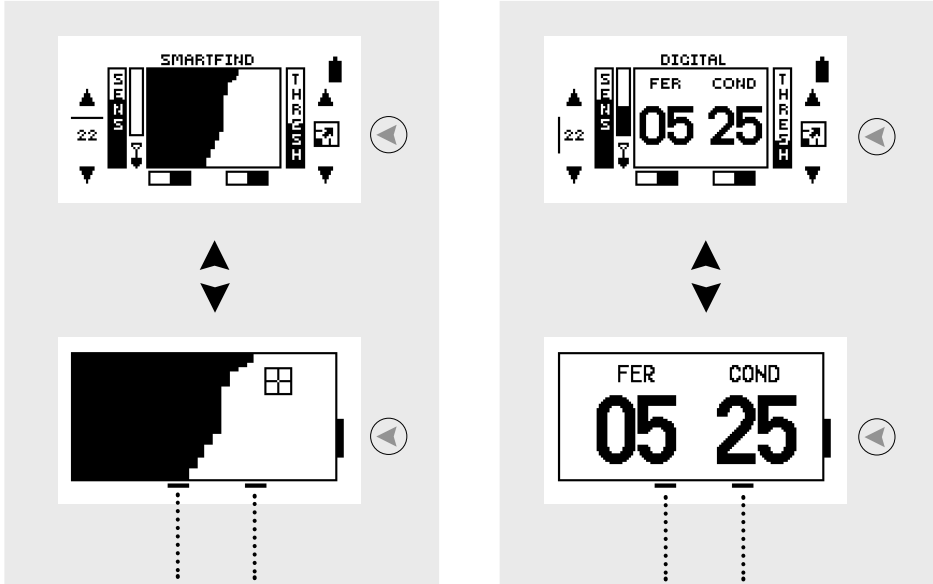

These bars line up with the text on the control panel, indicating whether Iron Mask and Pinpoint are on or off.

28 Smartfind™ Display

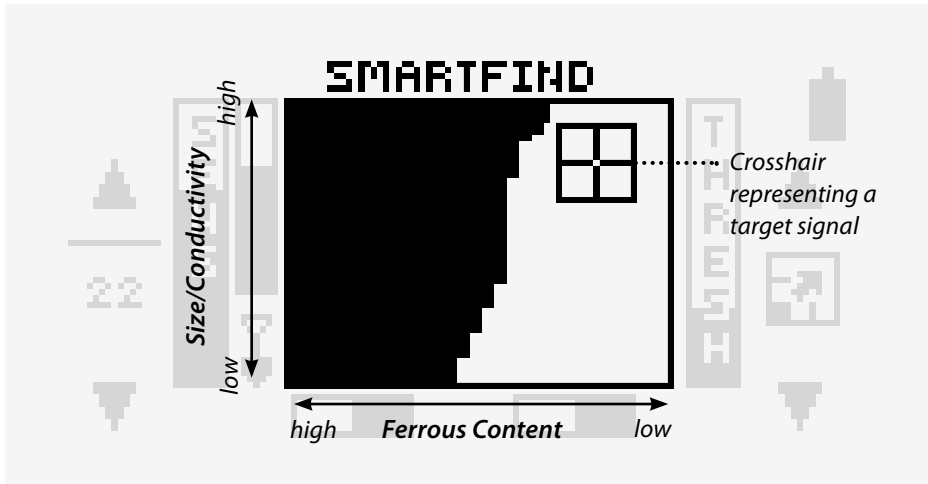

Smartfind is Minelab’s unique two dimensional scale of discrimination. The Explorer SE rates detected objects according to their conductivity (like most traditional detectors). What makes two dimensional discrimination unique is that the object’s ferrous content is also rated. Smartfind graphically represents both of these target properties on the same display.

The vertical dimension (or axis) rates the object on size/conductivity. The horizontal dimension (or axis) rates the extent of the object’s resemblance to ferrous characteristics. As the coil is passed over a target, the detector digitally processes the target signal and displays this as a Crosshair on the Smartfind window. The position of the Crosshair on the LCD is related to its conductive and ferrous properties.

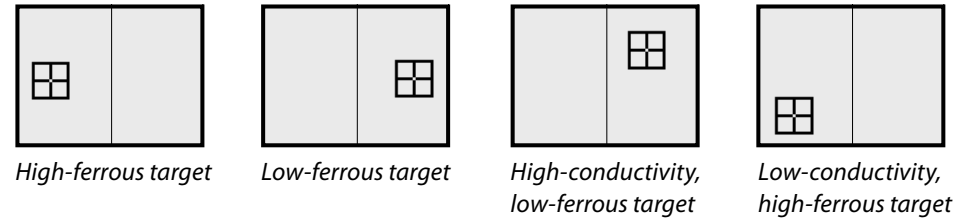

High-ferrous targets contain a large amount of iron (e.g. nails). A high-ferrous target is often magnetic and will generally display the Crosshair on the left side of the Smartfind window.

Low-ferrous targets have little or no iron content, such as pure gold, silver, copper and bronze. Low-ferrous targets will generally appear on the right side of the Smartfind window.

High-conductivity targets (e.g. large silver coins, copper items) will cause the Target Crosshair to appear at the top of the Smartfind screen.

Low-conductivity targets (e.g. small alloy coins, foil, 9ct and fine jewelry) will cause the Target Crosshair to appear at the bottom of the Smartfind screen.

The size of objects will have some effect on the conductivity rating for targets. Generally, the larger the target, the higher the corresponding conductivity rating (and proximity of the Target Crosshair to the top of the screen).

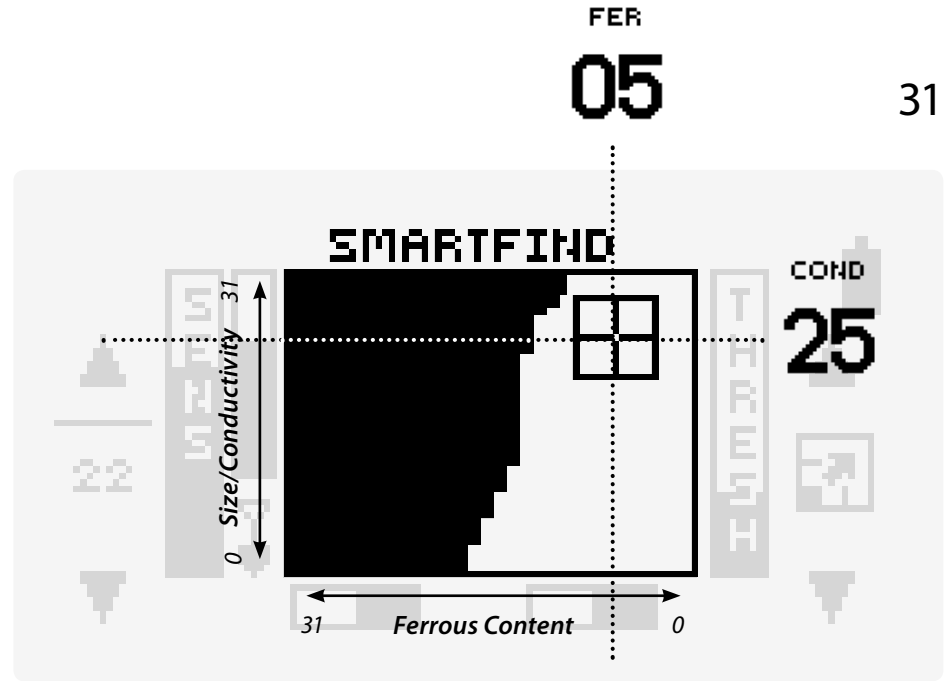
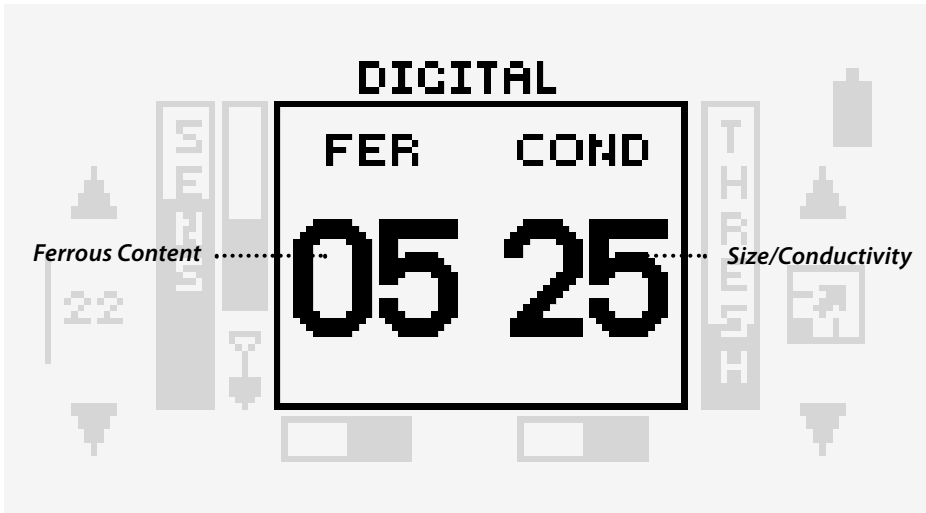

The Explorer SE has an alternative Digital display that shows both the ferrous content (FER) and the conductivity (COND) of a target with numbers from 0 to 31.

The FER and COND numbers are the coordinates of the Target Crosshair displayed in Smartfind.

A FER value of 0 represents low-ferrous content and a value of 31 represents high ferrous content. Similarly, a COND value of 0 represents low conductivity and 31 represents high conductivity.

It is important to note that when using Digital, discrimination settings (either the current Discrimination Pattern or the Iron Mask) are still active and targets outside the accepted area will not produce a signal or indicate FER and COND numbers on the display.

The conductivity and ferrous information of the target will clear as you switch between Smartfind and Digital, until a new detection is made.

The last used display will appear the next time you turn on the detector. Any adjustments to Discrimination Patterns that are made in Smartfind will be retained and used in Digital.

While detecting a target, try switching from Smartfind to Digital, to compare the results. In time, you may prefer to use different displays for different conditions.

To switch between Smartfind and Digital displays:

Press **DETECT**.

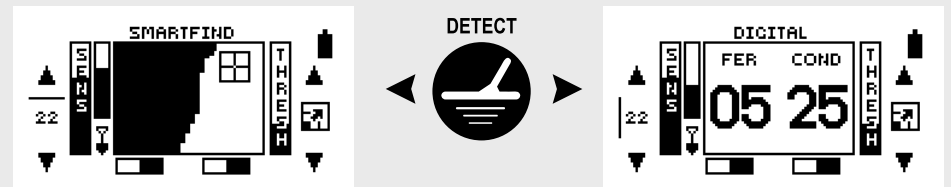

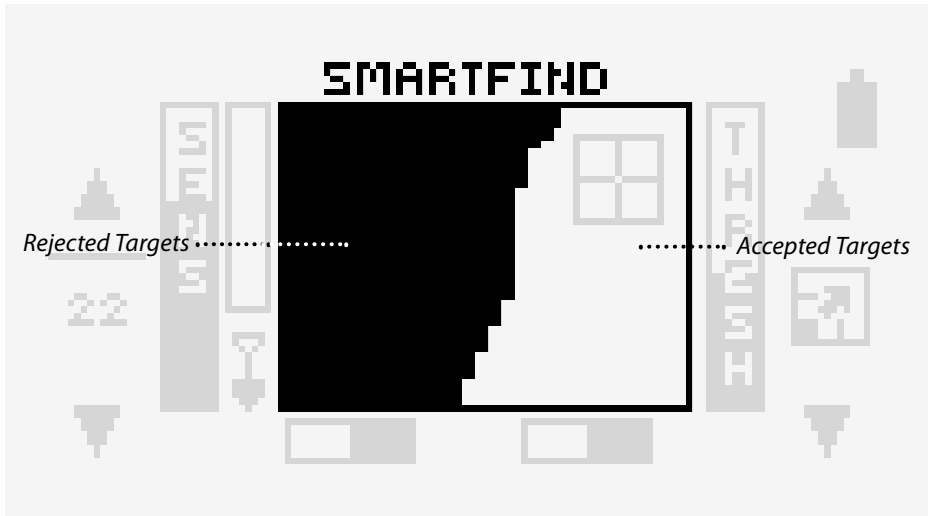

Discrimination is the detector’s ability to eliminate signals from undesired targets and accept signals from desired targets.

Each coordinate of the Smartfind window can be turned white or black to accept or reject certain targets, respectively.

White (clear) pixels indicate that those particular targets are accepted. Black pixels indicate that those particular target signals are rejected.

The combination of rejected and accepted pixels is referred to as a ‘Discrimination Pattern’.

The Pattern shown above is the default Discrimination Pattern of the Explorer SE. It accepts signals from non-ferrous coins and rejects signals from most high-ferrous targets.

When an accepted target is detected (matching the conductive and ferrous characteristics of coins), the Target Crosshair will appear in the white (clear) area of pixels and a target response will sound.

When a rejected target is detected (not matching the conductive and ferrous characteristics of coins), the Threshold will blank and the Target Crosshair will remain in the position of the last accepted target.

Explorer SE offers a range of Discrimination Patterns which may be used on their own or in combination. *(Select, pg. 40)*

The default Discrimination Pattern represents the typical characteristics of non-ferrous coins, a composite of hundreds of coins from around the world.

The Explorer SE has four different ways of changing the Discrimination Pattern to find only the types of targets you want:



Reduce or increase the amount of ferrous signals with **Iron Mask** (pg. 34).



Select from a preset list of Discrimination Patterns that correspond to common desired and undesired targets (pg. 40).

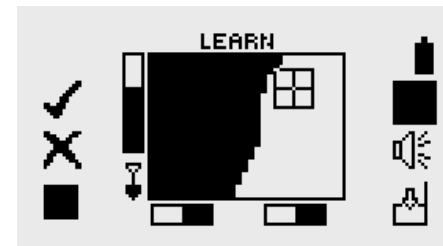

Use a target that you have previously found to create a Discrimination Pattern with the **LEARN** feature (pg. 44).

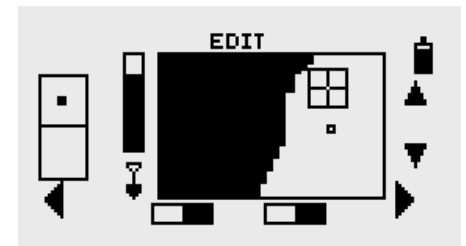

Manually **Edit** areas of the Discrimination Pattern (pg. 50).

34 Iron Mask - Setting the Level of Ferrous Rejection

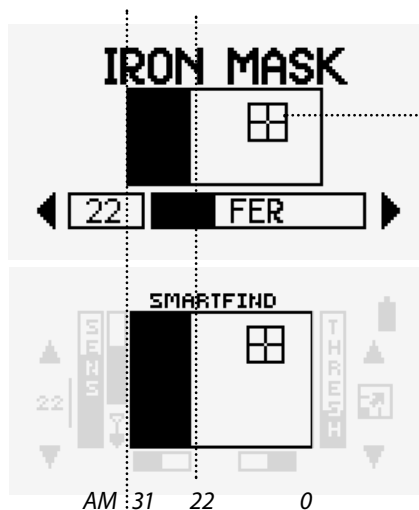

Iron Mask allows you to change the Discrimination Pattern by adjusting the level of ferrous rejection. Iron Mask can be turned on or off (switching back to Smartfind or Digital). The Iron Mask screen displays the Discrimination Pattern (similar to the Smartfind) and a slider control to adjust the level of ferrous discrimination. The level of ferrous discrimination can be adjusted using the shift buttons next to the slider control.

To accept more high-ferrous objects (e.g. war relics):

Reduce the level of ferrous rejection by pressing the bottom left shift button next to the slider control. You will notice that the number increases because the Iron Mask level refers to the horizontal ferrous scale ranging from 31 to 0. You may need to experiment a little with the settings.

To reject more high-ferrous objects:

Set the level of ferrous rejection to 16. This is represented by the mask extending to half way across the Smartfind screen (pg. 28).

Once adjusted, you can continue detecting in the Iron Mask adjustment screen, as accepted targets will still appear as a Crosshair in the clear area of the window.

Or you can choose to continue detecting in Smartfind with Iron Mask ON. The Smartfind window will adopt the new Iron Mask Pattern.

The **IRON MASK** shortcut button turns Iron Mask ON / OFF, switching between three screens:

- > Iron Mask ON - adjustment screen,
- > Iron Mask ON - Smartfind or Digital,
- > Smartfind or Digital (Iron Mask OFF).

The Factory Preset of 22 is suitable for rejecting most high-ferrous junk targets

Iron Mask

To turn Iron Mask ON (Adjust Iron Mask):

Press the **IRON MASK** shortcut button.

Press the bottom shift buttons next to the slider control to adjust the level of Iron Mask.

To detect with Iron Mask ON (Smartfind or Digital):

Press the **IRON MASK** shortcut button. The bar at the bottom of the Smartfind screen will indicate that Iron Mask is ON.

To turn Iron Mask OFF (and return to detecting in Smartfind or Digital):

Press the **IRON MASK** shortcut button. The bar at the bottom of the Smartfind / Digital screen will indicate that Iron Mask is OFF.

To reject a target using Iron Mask:

- 1 Create an All Metal Pattern (or recall it from the SAVE DISCRIM screen).
- 2 Switch to Digital display.
- 3 Detect a target and take note of its FER value.
- 4 Set the Iron Mask to that FER value. The target will now be rejected.

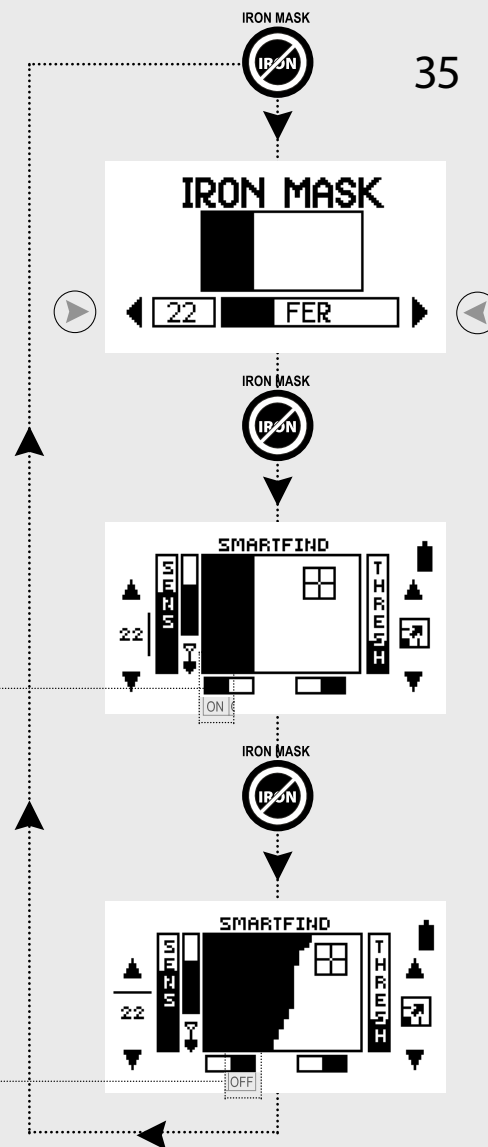

36 All Metal - Accepting All Targets

37

All Metal is the term used to describe a clear Discrimination Pattern, a Pattern that accepts all target signals, hence accepting all metals.

An All Metal Pattern can be created in two ways:

1 To create an All Metal Pattern in the Iron Mask Adjustment screen:

Press the shift button to reduce Iron Mask and clear the Discrimination Pattern. 'AM' will appear in the box.

2 To create an All Metal Pattern in the SELECT screen:

- 1 Access the SELECT screen:
MENU > SELECT
- 2 Press the shift button next to the CLEAR option. This clears the Discrimination Pattern thumbnail, creating a Pattern that will accept all metals.

To save the All Metal Pattern:

- 1 Access the SAVE DISCRIM screen:
MENU > SAVE DISC
- 2 Press the shift button corresponding to the location you want to save it to (e.g. S2).

The All Metal Pattern can then be recalled from the Select List in the SELECT screen.

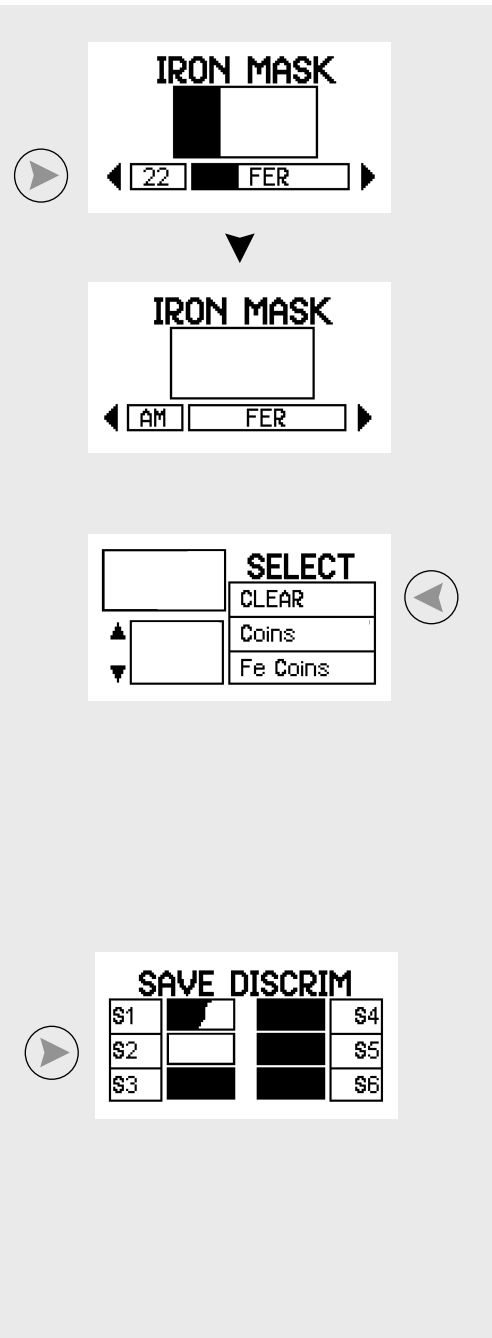

All detector settings (except Sensitivity and Threshold) are located in the menu. The menu can be accessed at any time during detecting.

- 1 Press **MENU**.
- 2 Press the shift button next to the menu option to select it.

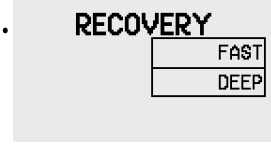
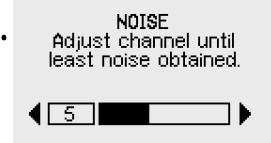
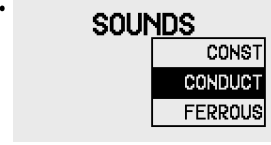
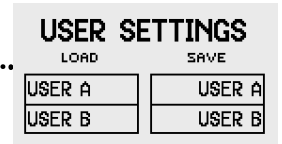
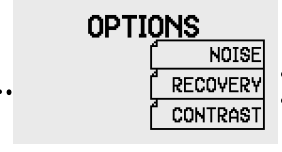
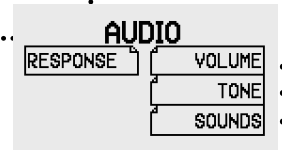
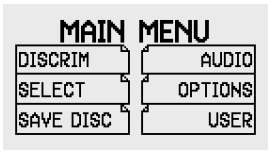
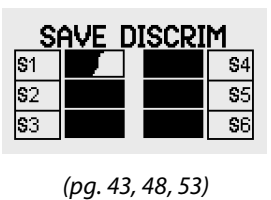
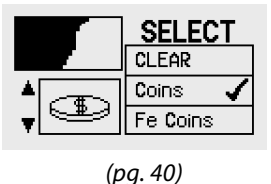
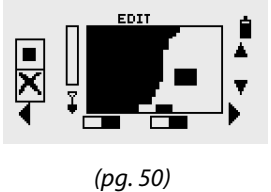
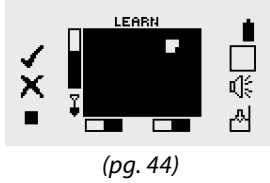

(pg. 62)

(pg. 58)

(pg. 60)

(pg. 64)

(pg. 56)

(pg. 54)

(pg. 55)

40 SELECT - Preset Discrimination Patterns

Discrimination Pattern Thumbnail

Shows the Pattern that is the result of your accepted or rejected Discrimination Patterns from the Select List.

Select List

Lists Discrimination Patterns for common targets. CLEAR is provided to clear the Discrimination Pattern.

Navigation Arrows
Indicate which direction the Select List can be scrolled.

Target Icon
Indicates the selected Discrimination Pattern.

Accept Icon

A tick indicates that the Discrimination Pattern for this target is accepted.

Reject Icon

A cross indicates that the Discrimination Pattern for this target is rejected.



CLEAR	
Coins	✓
Fe Coins	
Jewelry	✓
Foil	
Pull Tab	✗
Crowncap	✗
Screwcap	
Nail	
\$1	
\$2	
\$3	
\$4	
\$5	
\$6	

clears the Discrimination Pattern Thumbnail
low-ferrous coins
high-ferrous coins
rings, bracelets, necklaces
aluminium foil
aluminium ring from can
crown seal bottle cap
screw-on bottle cap
nails, screws, shards of rust

custom saved patterns

The SELECT screen lists eight types of targets (Discrimination Patterns) typically encountered during treasure hunting and six spaces where custom saved patterns can be retrieved.

Each Discrimination Pattern in the Select List is designed to accept the corresponding target type.

By accepting the Discrimination Pattern ✓, you are modifying the Discrimination Pattern Thumbnail to accept that target type.

By rejecting the Discrimination Pattern ✗, you are modifying the Discrimination Pattern Thumbnail to reject that target type.

A number of the Discrimination Patterns from the Select List can be accepted and rejected at the same time, creating a custom Pattern that can be saved for future use.

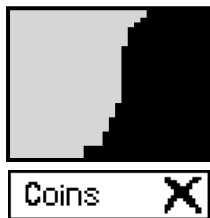
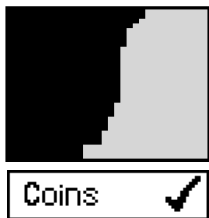

The Reject Icon (cross) inverses the Discrimination Pattern, rejecting that target type from the Discrimination Pattern Thumbnail.

If the SELECT screen is accessed while the Explorer SE is functioning in Iron Mask, the current Iron Mask Pattern will be displayed in the Discrimination Pattern Thumbnail.

As soon as a selection is made from the Select List, a thumbnail of the chosen Discrimination Pattern will replace the Iron Mask, and Iron Mask indicator will be automatically switched to the OFF position when you return to the Smartfind screen.

42 SELECT - Selecting Preset Discrimination Patterns

A number of Discrimination Patterns can be accepted and rejected at one time, creating a custom Pattern that can be saved for future use.

To scroll up or down the Select List:

Press the shift buttons next to the up/down arrows.

To clear the Discrimination Pattern Thumbnail (create an All Metal Pattern):

Press the shift button next to the CLEAR option.

To accept the Discrimination Pattern:

Press the shift button next to the Discrimination Pattern once to display a tick.

To reject the Discrimination Pattern:

Press the shift button next to the Discrimination Pattern until a cross is displayed.

Press the **DETECT** shortcut button to continue detecting in Smartfind / Digital with your new Discrimination Pattern.

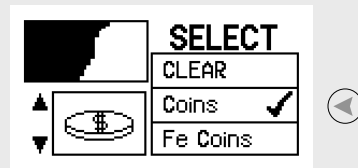
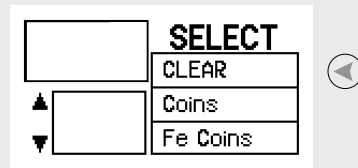
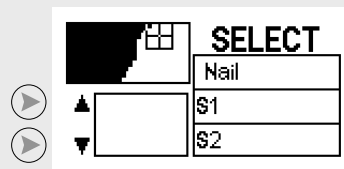

Rejecting a target inverses the Pattern



SELECT - Saving Discrimination Patterns

43

Once a new Discrimination Pattern has been created, it can be saved in one of six places in the SAVE DISCRIM screen.

To save the new Discrimination Pattern into the SAVE DISCRIM menu:

Press the shift button next to the location where you want it to be saved. The Discrimination Pattern can now be retrieved from the list of Discrimination Patterns in the SELECT menu screen.

Saved Patterns are not erased when factory preset settings are restored.

Be sure to save your new Discrimination Pattern, otherwise all changes will be lost once the detector is turned off.

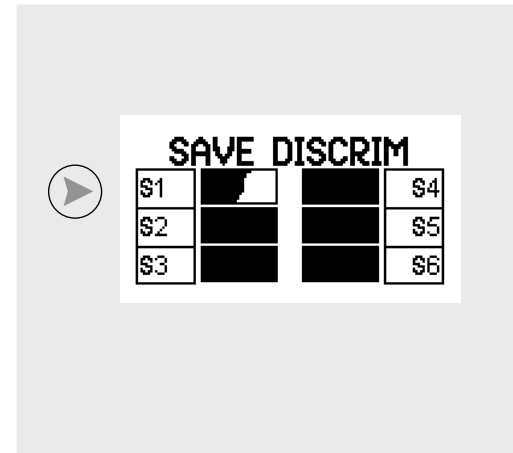

44 Learn - Creating a Discrimination Pattern with a Specific Target

Accept Target Icon
Modifies Discrimination Pattern to accept a specific item when icon is flashing.

Reject Target Icon
Modifies Discrimination Pattern to reject a specific item when icon is flashing.

Resize Cursor
This allows you to manually increase or decrease the size of the area modified on the screen by LEARN's response to a target.

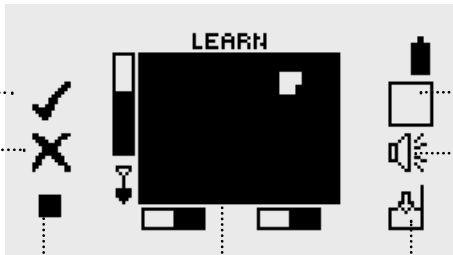

Discrimination Pattern
The black and clear areas of the screen schematically represent the current target Discrimination Pattern.

Save Icon
This shortcut icon leads to the SAVE DISCRIM menu where the current Discrimination Pattern can be saved.

Accept All / Reject All
Allows you to switch between clearing or filling the whole Pattern in preparation for rejecting or accepting learnt targets.

Volume Icon
This shortcut icon takes you to the VOLUME section of the AUDIO menu where you can adjust various Volume characteristics.

You may wish to instruct the Explorer SE to detect targets with very specific characteristics. It may be that you have found a particular type of coin which you would like to find more of, or you find yourself constantly unearthing the same types of junk.

The LEARN option instructs the Explorer SE to accept or reject precisely the types of targets you do or do not want.

Once saved, your new Discrimination Patterns can be used by themselves or in combination with other Discrimination Patterns in the SELECT screen (pg. 42).

In time, you may find LEARN one of the Explorer SE's most powerful features.

For instance, once you have saved several unwanted targets, you may exclude them all from your current Discrimination Pattern, simply by rejecting them from the Select List in the SELECT screen.

In a similar way, you could combine all of your desired targets into your own composite Discrimination Pattern.

For the LEARN option to work accurately, it needs to recognize the same target characteristics with each pass of the coil. Check that there are no other targets in the ground where you will be learning the target. Move away from other detectorists or powerlines.

Check for interference (erratic noises and random movements of the Target Crosshair). If you experience interference, press **NOISE CANCEL**, reduce the Sensitivity, or move the detector to a different area.

It may be useful to perform a Noise Cancel before learning a target.

46 Learn - Accepting a Target

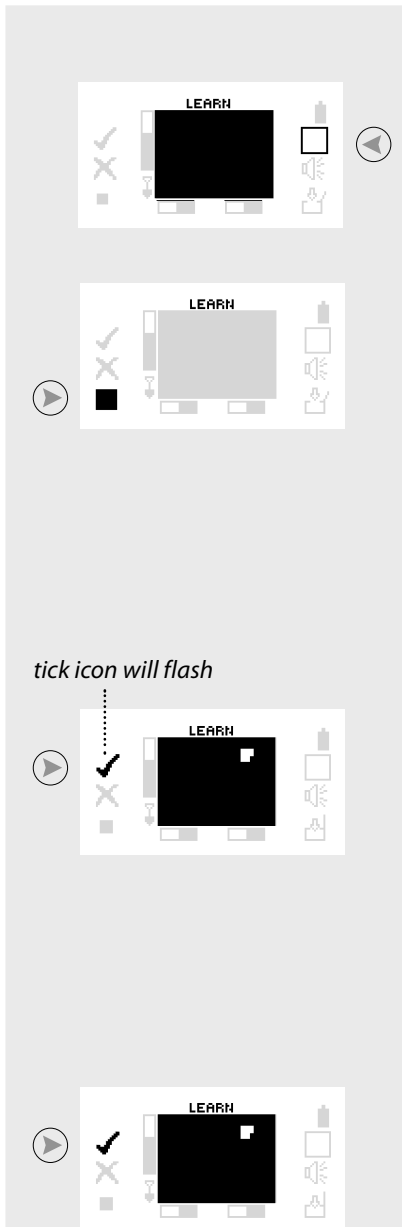

To create a Discrimination Pattern that accepts a target:

Fill in the Smartfind window:

Press the shift button next to the Reject All/Accept All icon. This fills in the Smartfind window, rejecting all targets and prepares the window for learning the new target.

Change the size of the cursor:

Press the lower left hand shift button to change the cursor size (small, medium or large). The size of the cursor sets how 'loosely' the targets ferrous and conductivity characteristics are recorded.

A large cursor will recognise a wider area of Pattern as that target, a small cursor will give a 'tighter' Pattern but may cause slightly altered or damaged targets to be ignored.

Learn (accept) the target:

- 1 Place the target on the ground.
- 2 Press the upper left shift button next to the tick (accept) icon. The tick icon will begin to flash, indicating that the next detected target will clear an area of pixels, creating a Discrimination Pattern that accepts that detected target.
- 3 Wave the coil several times above the desired target until the detector learns it by clearing an area in the Smartfind window. The Explorer SE needs to detect the target consistently to accept it in the Smartfind window. If you have more than one target, repeat the procedure for each one.
- 4 Press the shift button next to the flashing tick to disable the LEARN option.

Be sure to save your new Discrimination Pattern, otherwise all changes will be lost once the detector is turned off (pg. 48).

Learn - Rejecting a Target

47

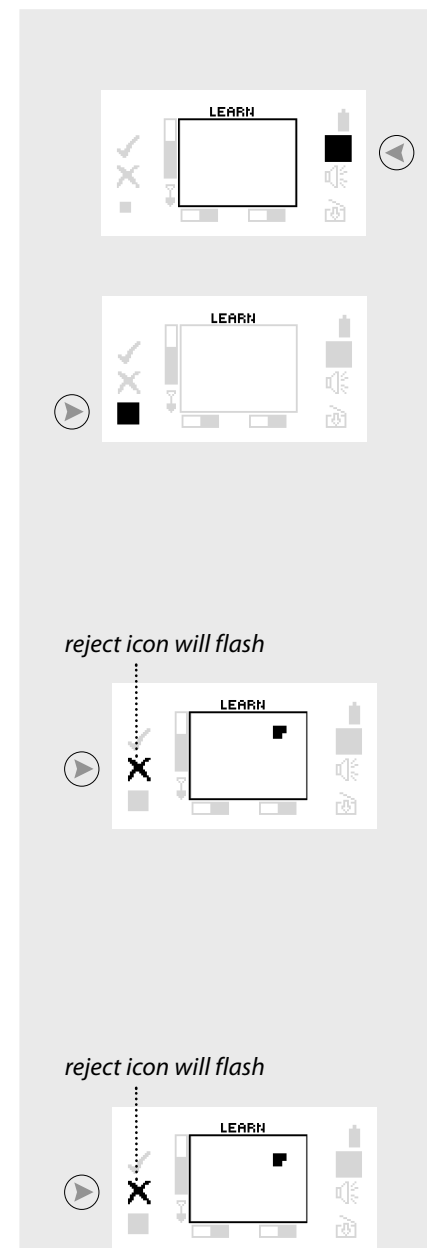

To create a Discrimination Pattern that rejects a target:

Clear the Smartfind window:

Press the shift button next to the Reject All/Accept All icon. This clears the Smartfind window, accepting all targets and preparing the window for learning the new target.

Change the size of the cursor:

Press the lower left hand shift button to change the cursor size (small, medium or large). The size of the cursor sets how 'loosely' the target is matched for each successive pass of the coil.

Learn (reject) the target:

- 1 Place the target on the ground.
- 2 Press the upper left shift button next to the cross (reject) icon. The cross icon will begin to flash, indicating that the next detected target will fill in an area of pixels, creating a Discrimination Pattern that rejects that detected target.
- 3 Wave the coil several times above the desired target until the detector learns it by filling in an area in the Smartfind window. The Explorer SE needs to detect the target consistently to reject it in the Smartfind window. If you have more than one target, repeat the procedure for each one.
- 4 Press the shift button next to the flashing cross to disable the LEARN option.

Be sure to save your new Discrimination Pattern, otherwise all changes will be lost once the detector is turned off (pg. 48).

48 LEARN - Saving Discrimination Patterns

To save the Discrimination Pattern:

- 1 Press the shift button next to the Save icon to go directly to the SAVE DISCRIM menu.
- 2 Press the shift button next to the location you want to save it to (e.g. S2). The learnt Discrimination Pattern can now be retrieved from the list of Discrimination Patterns in the SELECT screen.
- 3 Press **DETECT** to navigate to the EDIT screen where the Discrimination Pattern can be further edited in detail if required (pg. 49), or press **DETECT** again to return to Smartfind / Digital.

Saved Patterns are not erased when factory preset settings are restored.

Be sure to save your new Discrimination Pattern, otherwise all changes will be lost once the detector is turned off.

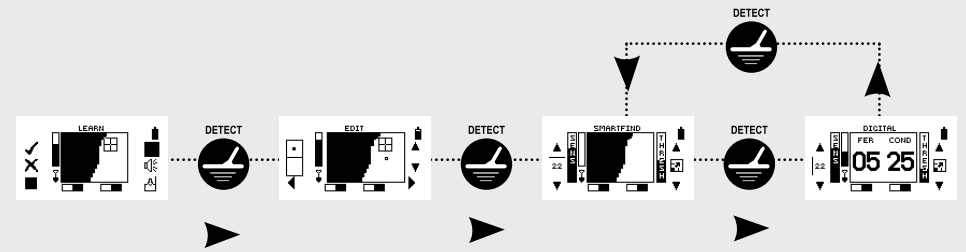
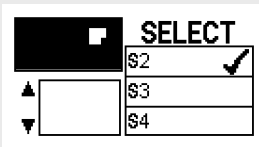

*The **DETECT** button will navigate through the Learn, Edit, Smartfind and Digital screens, then switch between Smartfind and Digital.*

50 EDIT - Editing Discrimination Patterns

Target Frame Size

This allows you to select the size of the framed area you wish to accept or reject from the displayed Discrimination Pattern. There is a choice of three sizes.

Discrimination Pattern

The shaded and unshaded areas of the screen schematically represent the current Discrimination Pattern.

Target Frame

Any area of the screen enclosed by this frame may be excluded from or become part of your preferred target Pattern.

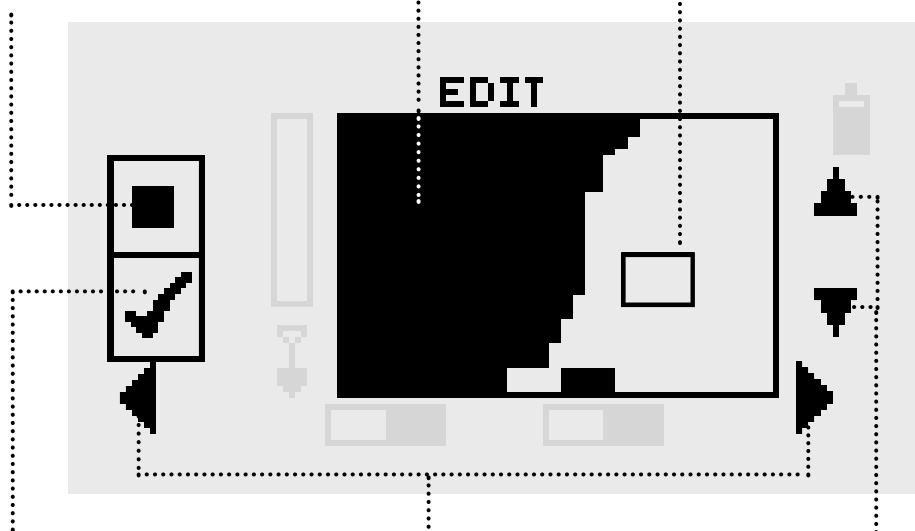

Accept or Reject Framed Area

Instructs Explorer SE to accept the framed area on selection of the tick icon. Selection of the cross icon will reject the framed area. This edits the current Pattern.

Horizontal Navigation

Pressing the shift buttons adjacent to these arrows moves the target frame to the left or right of the screen.

Vertical Navigation

Pressing the shift buttons next to these arrows moves the target frame up or down the screen.

EDIT enables you to make manual changes to individual areas (specific pixels) of the Discrimination Pattern.

LEARN may not provide the exact discrimination result you wanted (even when using a different-sized cursor). Rather than start all over again, you can just 'touch up' your learn results. Similarly, you may find that the Discrimination Pattern for a specific target type (e.g. foil) may need to be modified to suit your requirements.

Make sure Pinpoint is OFF before using EDIT to customize your Discrimination Pattern.

52 EDIT - Editing Discrimination Patterns

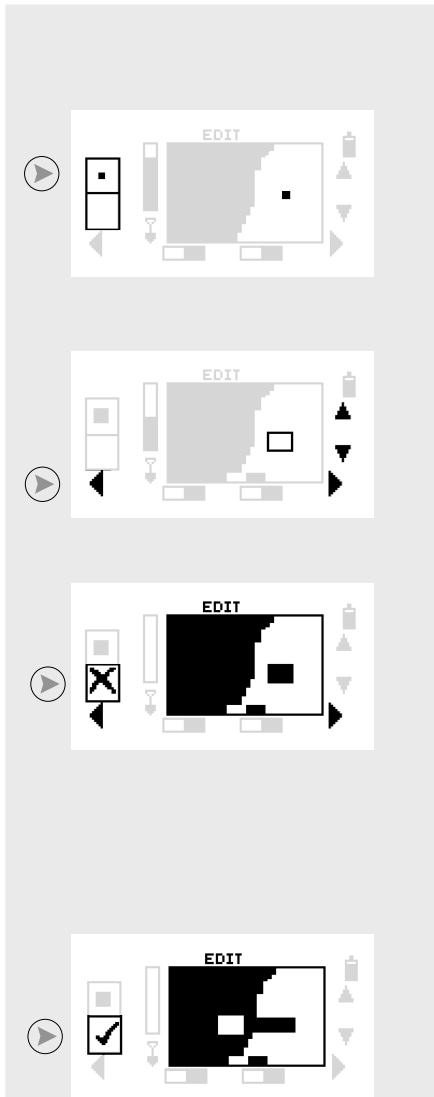

Select the Discrimination Pattern that you would like to edit (*Select, pg. 40, Learn pg. 44*).

To change the size of the target frame:

Press the top left shift button to switch between three target frame sizes.

To move the target frame:

Press the shift buttons next to the navigation arrows. Position the resized frame over the screen section you wish to edit.

To reject the framed area:

Press the center left shift button once. You will note that a cross appears next to the button and the area of screen within the target frame has turned black. You can now move the target frame in any direction using the horizontal and vertical navigation arrows.

To accept the framed area:

Press the center left shift button until a tick appears next to the button. This instructs the Explorer SE to clear the framed area.

Be sure to save your new Discrimination Pattern, otherwise all changes will be lost once the detector is turned off.

53 EDIT - Saving Discrimination Patterns

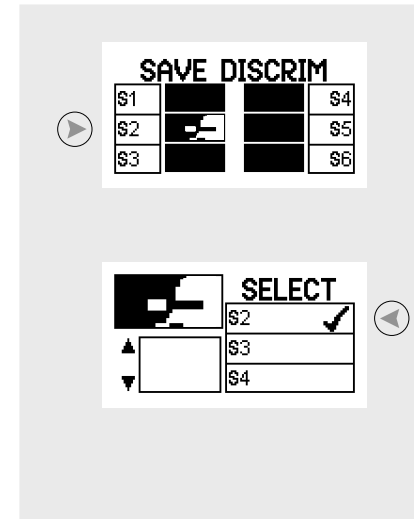

To save the edited Discrimination Pattern:

- 1 Press the **MENU** shortcut button and select SAVE DISC from the menu.
- 2 Press the shift button next to the location you want to save it to (e.g. S2). The edited Discrimination Pattern can now be retrieved from the list of Discrimination Patterns in the SELECT menu screen.

Saved Patterns are not erased when factory preset settings are restored.

Be sure to save your new Discrimination Pattern, otherwise all changes will be lost once the detector is turned off.

54 RECOVERY - Enhancing Explorer SE Performance

RECOVERY allows you to select the way the discrimination process works. RECOVERY settings affect both the detector's audio and display response to target characteristics.

FAST

By selecting this setting, the detector will react faster to the signals received, but the discrimination and target ID may be slightly less accurate. Use FAST in areas littered with objects, where a desired target could be hiding next to unwanted objects.

DEEP

This setting affects only weak target signals and enhances them to allow identification of deep targets. This setting should be selected in relatively uncluttered areas where deep targets are anticipated. Strong signals are unaffected.

In the DEEP setting there will be a slightly slower reaction in target signal and target ID due to the more detailed processing of the target characteristics.

To select a RECOVERY setting:

1. Press the shift button next to the desired RECOVERY setting.
2. Press **DETECT** to return to Smartfind/Digital and continue detecting.



CONTRAST

55

The LCD may be hard to see in bright or overcast conditions.

To adjust LCD Contrast:

Press the shift buttons next to the arrows of the slider control to adjust the contrast of the LCD.

Press **DETECT** to return to Smartfind and continue detecting.

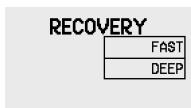
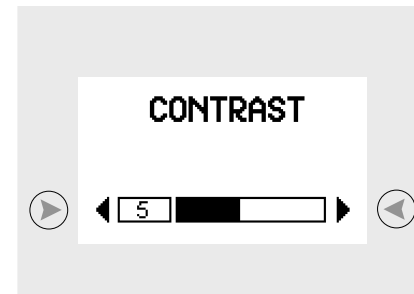

Best compromise of depth, audio response, Target ID and discrimination for normal detecting conditions.

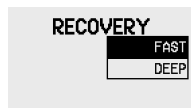

Better audio response in 'trashy' areas at the expense of target ID and discrimination accuracy.

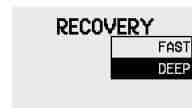

Improved audio response for weak signals, in less cluttered environments.



Less accurate discrimination and Target ID; amplified signals for small targets, response time is similar to DEEP=OFF, FAST=OFF.

56 NOISE CANCEL - Reducing Electrical Interference

The detector may become noisy due to electrical interference from powerlines, electrical equipment or other detectors operating close by. The detector interprets this interference as inconsistent, short beeps, and erratic movement of the Target Crosshair on the Smartfind display, or erratic changing of FER COND numbers in the Digital display.

The Noise Cancel channel can be changed so that the detector experiences the least interference for the current environment. The channel can be changed automatically by the **NOISE CANCEL** shortcut button, or manually in the NOISE CANCEL screen via the menu.

The **NOISE CANCEL** button instructs the detector to automatically listen to every channel and select the quietest channel. Automatic Noise Cancel may take up to 30 seconds.

The NOISE CANCEL screen, accessed via the menu, allows you to manually select and listen to every channel for the least interference.

Once a channel is selected, most audio responses to electromagnetic disturbances (e.g. powerlines) will be eliminated.

Noise Cancel is handy for metal detecting competitions when several Explorer SEs are working close to one another. Each detector can be set to operate on a different channel so interference between detectors is eliminated. In this case it is best to select the channels manually.

If you would like to know what channel has been chosen after an automatic Noise Cancel, access the NOISE CANCEL screen and check the channel displayed.

It is best to select a channel with the coil in the detection position, 30cm away from the ground and as still as possible. This gives the detector the best chance of hearing all surrounding interference (not from the ground or targets) and selecting the quietest channel.

It may be useful to switch to Manual Sensitivity from the Smartfind or Digital screen before attempting to perform Noise Cancel.

The number associated with Noise Cancel does not denote an increase or decrease in power. It is simply a channel number which can be remembered.

If you perform an Auto Noise Cancel while in the NOISE CANCEL screen, you will have to exit and return to the screen for the new channel to be displayed.

To automatically select a Noise Cancel channel:

- 1 Hold the detector 30cm above the ground, making sure there are no large targets or obvious electrical interferences close by.
- 2 Press the **NOISE CANCEL** button. Keep the detector completely still during the automatic channel selection. This may take up to 30 seconds.

The detector will select the quietest operating channel.

To manually select a Noise Cancel channel:

- 1 Hold the detector 30cm above the ground, making sure there are no large targets or obvious electrical interferences close by.
- 2 Access the NOISE CANCEL screen via the menu.
- 3 Use the shift buttons next to the adjustment arrows to select a channel listening for interference (or 'noise'). Adjust the detector to a new channel and listen again. Listen to each channel and select the one with the least amount of noise.

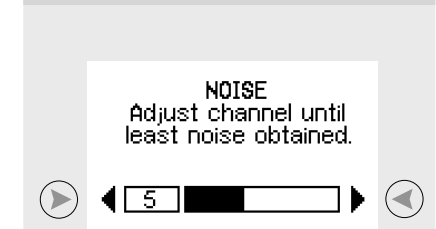
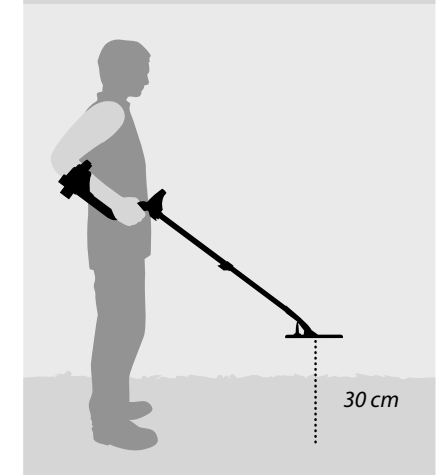
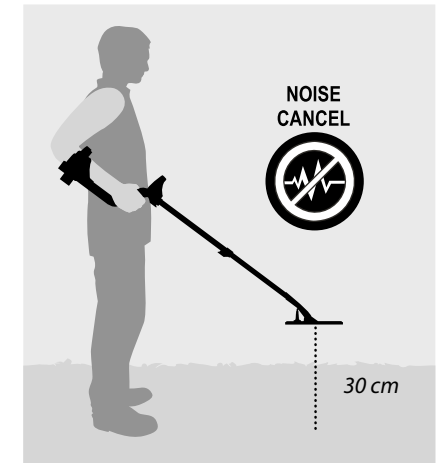

58 VOLUME

Volume is the level of sound emitted by the detector when a target is detected.

A high Volume will give a great difference between a small and large target, but may be dangerous to your hearing if a large target is found.

The Explorer SE is factory preset at maximum Volume. This is usually appropriate with either the detector's built-in speaker or headphones. If the Volume is too loud in the headphones, use the Volume control.

Headphones allow you to discern subtle variations in audio response and lessen exposure to adverse conditions (i.e. wind) which may distort sound from the speaker. Headphones also minimize disturbance from your treasure hunting for other people in the area.

Lower Volume settings and using headphones will extend battery life.

MAX LIMIT

The MAX LIMIT is the overriding Volume. It sets the maximum Volume of target signals.

The sound produced by a distant target starts softly. As you get closer, the Volume level increases rapidly until it reaches the maximum level that has been set.

To adjust the MAX LIMIT:

Press the shift buttons next to the MAX LIMIT slider control.

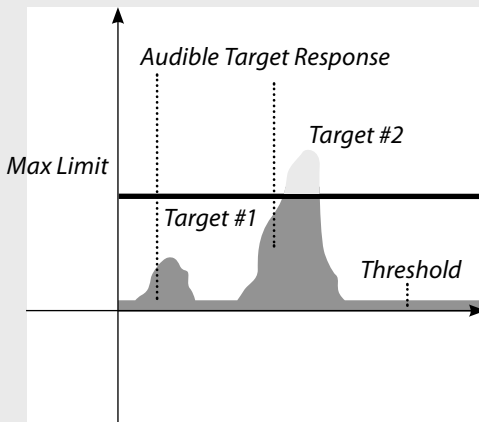
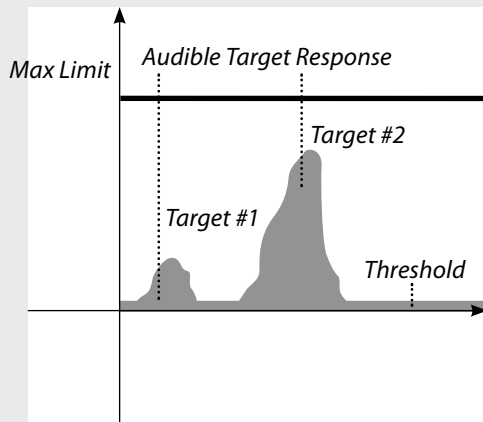
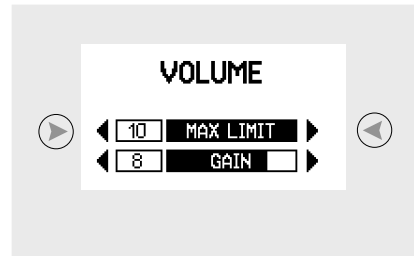

When Volume and Threshold settings are used together, there is a greater control over target audio response.

59

GAIN

This controls the amplification of target audio responses in respect to the strength of the original signal.

With a setting of 1 the target signal will be unamplified. Weak target signals will sound soft, medium target signals will sound medium and strong target signals will sound loud. There will be greater differentiation between target signal strengths. The weakest signals will produce an accordingly faint audio and may not be heard.

With a setting of 5, the audio response is being partially amplified. Weak to medium strength signals will give proportional volume, but strong signals will not sound much louder than medium signals because the Volume has reached its maximum limit.

With a setting of 10, all signals will be amplified to a very strong audio response. It will be harder to differentiate medium to strong signals, but even weak target signals will be easier to hear.

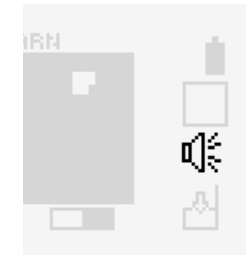

It is also possible to access the VOLUME screen menu from the icon shortcut of the LEARN screen.

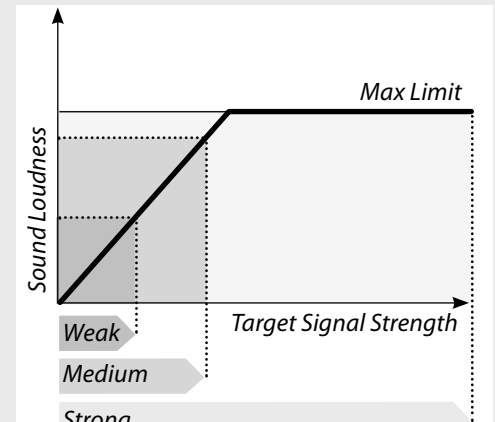
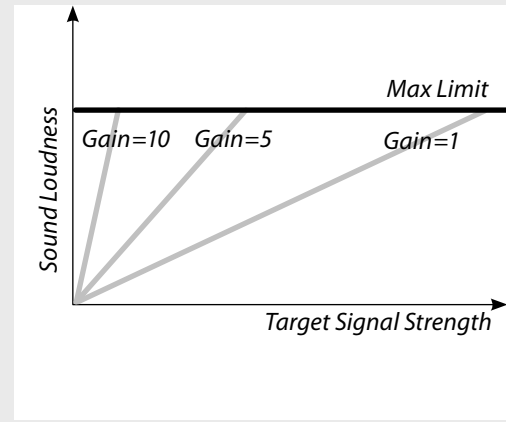

60 TONE - Adjusting Audio Pitch

Tone is the pitch of sound emitted by the detector. Adjusting Tone can help identify one target from another.

THRESHOLD TONE

TH. TONE allows you to adjust the tone of the Threshold 'hum' to best suit your own hearing.

A high Threshold tone is often preferred by people with good hearing, where a low Threshold tone is preferred by people with hearing difficulties.

To adjust TONE settings:

Ensure that CONDUCT is selected from the SOUNDS screen (pg. 64) and that the Threshold Volume and the Volume MAX LIMIT are appropriate for your environment (i.e. for headphones or speaker use, ambient noise etc.)

- 1 Adjust the THRESHOLD TONE to what you are comfortable with. This should be the tone you can hear most clearly.
- 2 Using two targets you are likely to often seek (which display a difference of 1 or 2 on the Digital COND reading) adjust VARIABILITY so you can hear the difference between one and the other.
- 3 Select a target with high conductivity (giving a high number on the Digital display) and wave it past the coil. Adjust LIMITS for a tone as high as possible but still within the range where you can hear well.



61

VARIABILITY

VARIABILITY controls how much the tone will change depending on the target's characteristics. It can help to separate targets of different characteristics.

A high variability represents a significant variation of tone from target to target.

A low variability represents a minimum variation of tone from target to target.

LIMITS

This sets the upper limit of all tones emitted by the Explorer SE.

A low limit will produce only low tone target signals.

A high limit will provide very high tone signals as well as low tone signals.

Minelab recommends setting the upper limit to the highest tone you are comfortable with.

Try testing LIMITS with a highly conductive object such as a large silver coin.

High VARIABILITY

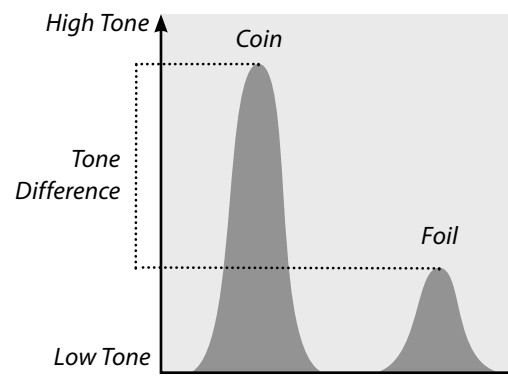

Low VARIABILITY

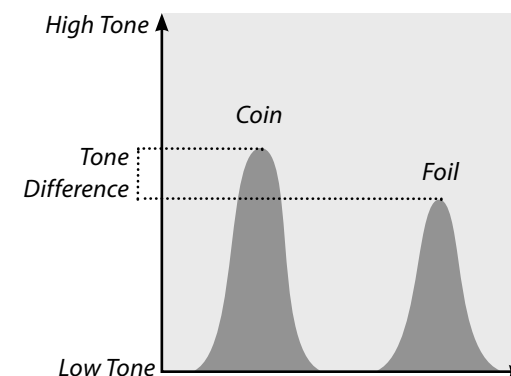

Range: NORMAL, LONG, SMOOTH, PITCH HOLD
 Factory Preset: NORMAL

62 RESPONSE - Selecting the Way Targets Sound

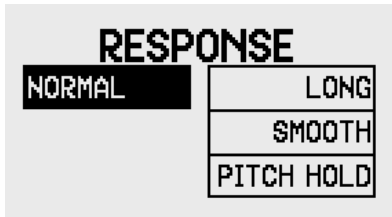

The RESPONSE option allows you to select the way target signals sound upon detection. RESPONSE can improve your ability to identify certain targets in differing circumstances.

As the coil is swept over a target, the target signal rises. At the peak of the target signal, audio is emitted.

Minelab recommend learning the detector in the factory preset NORMAL audio response. After you are familiar with the way the Explorer SE interprets various targets, then feel free to experiment with the various options.

Each response may work better in a different scenario and you will quickly develop your own preferences.

NORMAL
 Emits a short response to targets (almost a 'beep'). NORMAL is recommended for general detecting conditions. It allows the greatest differentiation between the ground and a target, but has the potential to miss small targets in areas littered with objects producing a target response.

LONG
 Offers an almost continuous audio response. This setting is ideal for responding to several targets close together. It is recommended for the experienced user, who can pick the differences in tone between various targets. LONG can be more confusing for the beginner but has the potential to offer greater accuracy and depth.

SMOOTH
 This setting is similar to LONG, with the addition of some filtering of the audio tone response. SMOOTH reduces the variability of the pitch, offering a smoother continuous sound.

PITCH HOLD
 Offers a target audio response similar to NORMAL (almost a 'beep'). When PITCH HOLD is selected, the tone of the Threshold also changes - after the target signal is heard, the Threshold 'hum' returns in a pitch similar to the pitch of the signal. The Threshold tone will not change on rejected targets, so if the Threshold changes on even the faintest response, you probably have a very small or very deep target to recover. The pitch of the Threshold will not change until a new detection is made.

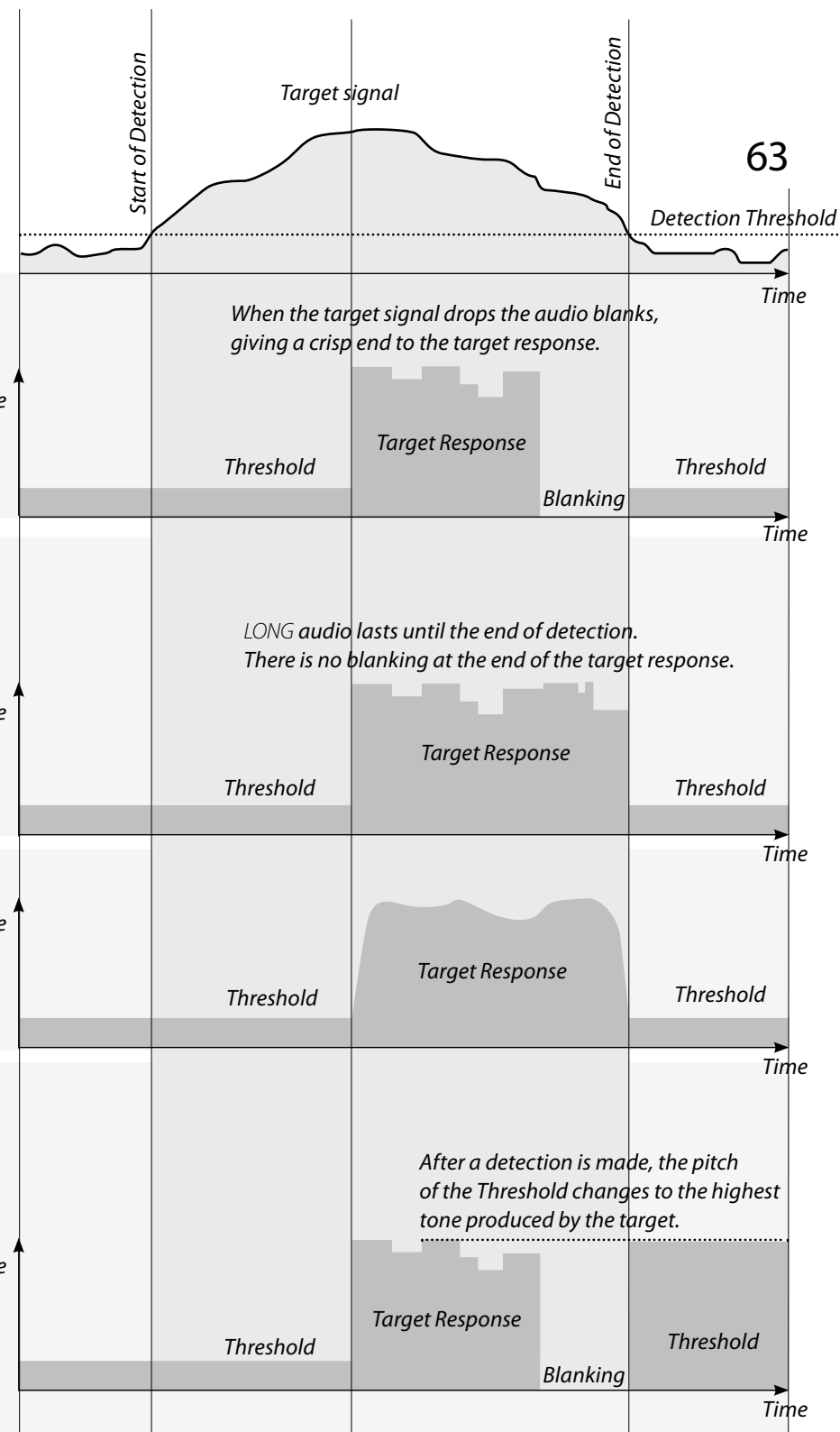

Range: CONST, CONDUCT, FERROUS
 Factory Preset: CONDUCT

64 SOUNDS - Tone Identification

The SOUNDS menu allows you to define how the tone varies with target characteristics. This can be a very useful feature in identifying targets close to each other.

It is possible to instruct the detector to emit a distinct sound responding to an object's ferrous characteristics, rather than its conductive properties. To test sounds upon selection it is necessary to move the coil across one or more targets with different conductive and ferrous properties.

Try testing the SOUNDS settings with an All Metal Pattern and a range of different targets (pg. 36).



CONST

Selecting CONST eliminates the variation of the tone upon detection. All targets regardless of ferrous or conductivity information will sound the same.

CONST is a good option for new users who find the different tones a little overwhelming.

PITCH HOLD will not function with CONST selected.

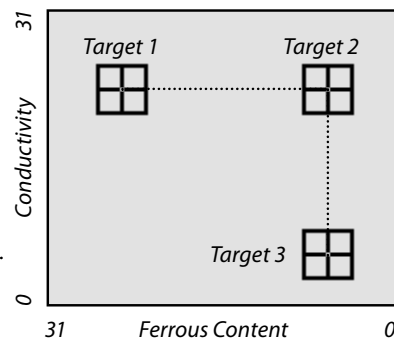
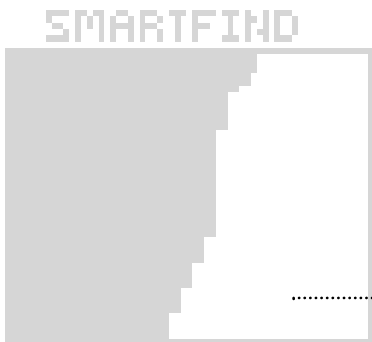

Targets 1, 2 and 3 will produce identical tone response.

CONDUCT

This is the Factory Preset selection. CONDUCT emits the tone according to the target's conductivity (the vertical axis of the Smartfind screen).

A high tone signal denotes a large, highly conductive object with Target Crosshair displayed near the top of the Smartfind screen (or near a Digital rating of 31). A low tone denotes a small object with low conductivity. The Target Crosshair is displayed near the bottom of the Smartfind screen (or near a Digital rating of 1).

CONDUCT is often preferred by coin hunters, as desirable targets such as gold, copper and silver coins will give a high tone signal response. Compared to lower conductive junk targets such as foil and pull tabs.

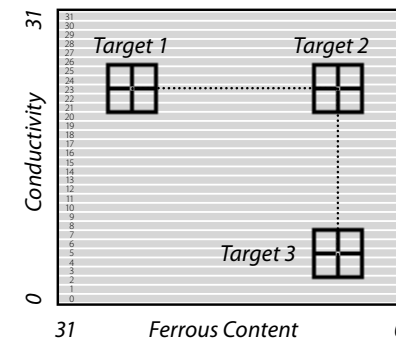

Targets 1 and 2 will produce an identical high tone response as their conductivity is the same (COND 23).

Target 3 will produce a much lower tone response as it has a much lower conductivity rating (COND 5).

FERROUS

Selecting FERROUS emits the tone according to the target's ferrous content (the horizontal axis of the Smartfind screen or the first number in the Digital display).

A low 'blaat' tone denotes a highly ferrous object, displayed on the left of the screen and having a high FER number. A high pitched 'squeak' tone denotes a non-ferrous target, displayed on the right of the Smartfind screen and having a low Fer number.

Ferrous is often preferred by relic and jewelry hunters as low conductive targets will often give a higher pitched signal compared to CONDUCT, as shown by target 3 in the example below.

It may be logical to select FERROUS if searching in Iron Mask, that way there is no chance of a high-ferrous target producing a high tone signal due to its high conductive characteristics.

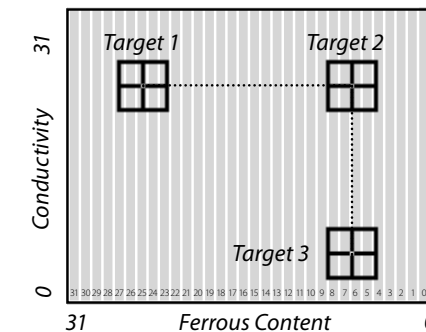

Targets 2 and 3 will produce an identical high tone response as their ferrous content is the same (FER 6).

Target 1 will produce a low tone response as its ferrous content is high (FER 25).

66 Pinpointing - Locating the Target

The exact location of a target can be located by using **PINPOINT**.

In normal operation, the Explorer SE is a motion detector, meaning it must be moving over a target to detect it.

Enabling Pinpoint instructs the detector to temporarily disengage Discrimination Patterns and become a non-motion detector, therefore targets normally discriminated against will emit a signal when underneath the coil.

In Pinpoint, the detector gives a continuous audio response. This response will get louder as the coil passes directly above the target.

The Pinpoint audio response is tone and volume modulated. The difference in tone and volume produced will help locate the position and depth of the target.

In Pinpoint, the depth and Crosshair or FER, COND are updated. This is useful for identifying other targets next to the target you want to recover.

- 1 Once the approximate target location is known, move the coil away from that area and press **PINPOINT**.
- 2 Sweep the coil slowly over the target location.
- 3 Taking note of the response, reduce the span of each successive pass of the coil until you are confident of the location of the target. Make a mental note of the position, or mark a line on the soil with your shoe or a digging tool.
- 4 Move to one side so that you can pass the coil over the target at right angles to your initial direction. When the detector sounds you should know exactly where to dig.

The detector may become noisy if Pinpoint is enabled above a target. The detector may also become noisy if left in Pinpoint. If this occurs return to normal detection, and try Pinpoint again.

Even though the Target Crosshair and FER COND numbers are updated in Pinpoint, Pinpoint is not recommended for normal detecting. In Pinpoint the detector "locks" onto the strongest target signal, which may result in missing targets in trashy areas.

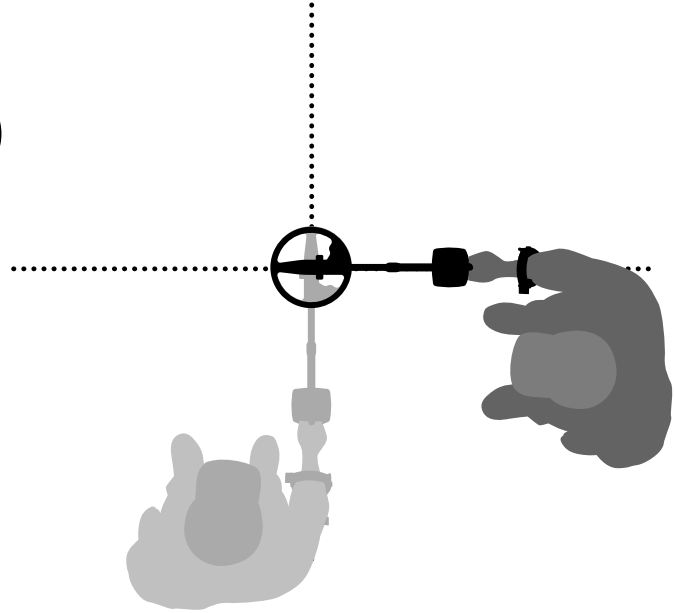
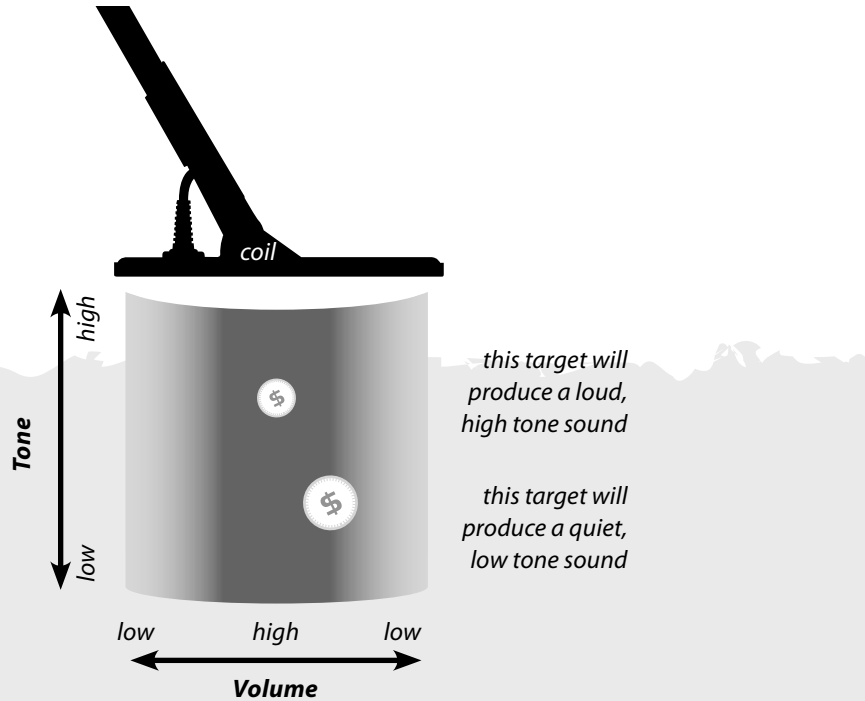

68 Recovering the Target

A trowel, knife or small spade are good tools for recovering targets.

Once a target has been located, clear the surface of loose material and check again for a signal. If there is no signal then the target is amongst the surface material. In this case, search the surface material until the target is located. If the target is still in the ground, Pinpoint its position.

When digging, the aim is to leave the area of ground exactly as you found it. Using a sharp tool, cut a neat portion of grass or soil and place it on a plastic sheet. This prevents the material being scattered around and allows the hole to be refilled quickly. Dig carefully to avoid defacing or devaluing the object.

Check the hole for the target. If it is not in the hole, place the detector on the ground with the coil flat, pick up a handful of soil and pass it over the coil. Be sure not to wear rings, bracelets or a watch which will produce a signal. Repeat this procedure until the target is located.

Ensure that no other targets remain, then refill the hole. All soil and portions of grass on the plastic sheet should be returned to the hole as neatly as possible. Step lightly on the soil to compact it.

Leaving holes, or a scarred area, may result in action being taken to prevent the use of metal detectors. Please ensure that you remove all rubbish and leave an area of ground as you found it.

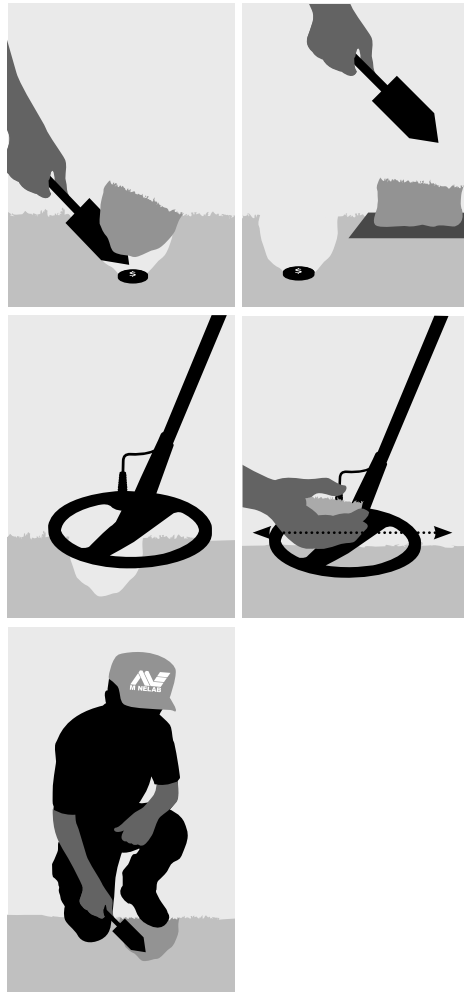

A simple and effective target probe can be made from a large flat-end screwdriver. Round off the tip of the screwdriver with a file to minimise damage to targets.

Ask for permission before searching on private property.

Where Will I Find Treasure?

69

A question most new detectorists ask is where do I find treasure? There are actually lots of areas in which you can search, and it is best if you research where people have been in the past, and what type of objects they may have had with them, and hopefully lost. You can also go to areas people still use on a daily basis such as the beach or parks, and look for modern coins and jewelry.

Here are a list of some of the more productive places to search, but be sure you obtain permission before entering any private property:

- > Your own backyard
- > The beach
- > Showgrounds & racecourses
- > Picnic areas
- > Battlefields
- > Camping grounds
- > Swimming holes
- > Parks and playgrounds
- > Ghost Towns & ancient town sites
- > Old homes & public buildings
- > Old gold mining sites
- > Sports grounds
- > School yards and ovals
- > Around jetties and piers
- > Drive-in theatres

Basically, anywhere people have been in the past there is a chance you'll find buried treasure - coins, relics, and jewelry lost years ago are sitting in the ground waiting to be found, and are also being replenished on a daily basis! The trick to maximising your return is to select sites that have the most potential.

For example, a small park that is just used as a walkway between houses is likely to be littered with junk with very few valuable targets in it. Whereas a larger old park with picnic tables, playgrounds, etc. would have had thousands of people sitting around, playing sports, laying on blankets etc. and you can almost be certain that there will be some goodies waiting for your metal detector.

In addition to obtaining land owners permission before searching on private property, be sure to check local regulations, and always refill your holes. If you leave the ground exactly as you found it, you shouldn't have any problem detecting the same area in the future.

70 USER SETTINGS - Saving Your Preferred Settings

Changes to detector settings (e.g. Volume, Tone and Sensitivity), are automatically saved. The detector remembers these settings when it shuts down. However, you may find that different locations require a separate combination of settings for maximum effectiveness.

Two people may have different preferences (e.g. Threshold, Response) or perhaps you divide your time between a couple of very different detecting environments (e.g. the beach and a highly-mineralized battlefield).

To save current settings:

Press the shift button next to SAVE - USER A or USER B.

A screen prompt will appear asking if you want to save current settings in the memory. Select OK.

You can now proceed to detect with these settings, knowing they have been saved for future use in similar conditions.

USER SETTINGS provides you with two sets of memorized settings, USER A and USER B. These sets can be used as an alternative to the factory presets. USER SETTINGS allows you to load your own defined settings saving you from having to 'set-up' the detector every time you turn it on.

To load saved settings:

Press the shift button next to LOAD - USER A or USER B.

A screen prompt will appear asking if you want to discard your current detector settings and load the memorized settings. Select OK.

Settings will load in approximately 3 seconds.

User Preferences

SETTING	RANGE	FACTORY PRESET	USER A	USER B
Sensitivity Mode	<i>Semi-Automatic, Manual</i>	<i>Semi-Automatic</i>		
Sensitivity Value	1 to 32	22		
Threshold Volume	0 to 40	16		
Discrimination Function	<i>Discrim, Iron Mask</i>	<i>Discrim</i>		
Iron Mask Value	0 to 31, All Metal	22		
Noise Channel*	1 to 11	5	x	x
Display Type	<i>Smartfind, Digital</i>	<i>Smartfind</i>		
Display Size	<i>Normal, Full Screen</i>	<i>Normal</i>		
Contrast	1 to 10	5		
Learn Cursor Size	<i>Small, Medium, Large</i>	<i>Large</i>		
Edit Frame Size	<i>Small, Medium, Large</i>	<i>Small</i>		
Audio Volume Max Limit	0 to 10	10		
Audio Volume Gain	1 to 10	8		
Audio Threshold Tone	1 to 10	5		
Audio Tone Variability	1 to 10	8		
Audio Tone Limits	1 to 10	10		
Audio Sounds	<i>CONST, CONDUCT, FERROUS</i>	<i>CONDUCT</i>		
Audio Response	<i>NORMAL, LONG, SMOOTH, PITCH HOLD</i>	<i>NORMAL</i>		
Options Recovery Fast	On, Off	Off		
Options Recovery Deep	On, Off	Off		

* Noise Channel is selected automatically by the **NOISE CANCEL** shortcut button or manually through MAIN MENU > OPTIONS

The Noise Channel cannot be saved into USER A or USER B.

Other selections not saved: Backlight status, Pinpoint.

Restoring Factory Presets will not delete any saved USER A or B settings.

Restoring factory presets discards all unsaved adjustments, except the saved Discrimination Patterns and USER A and USER B settings.

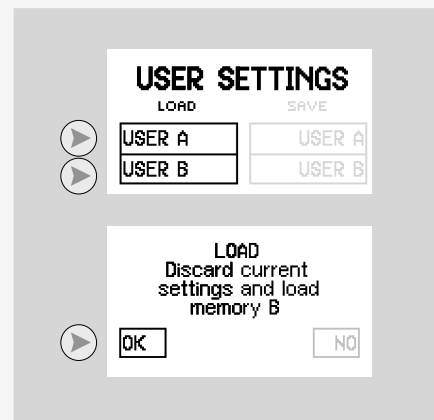
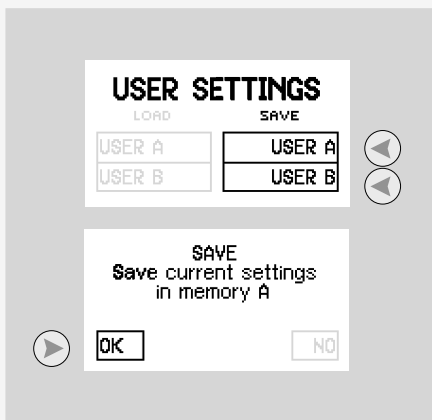

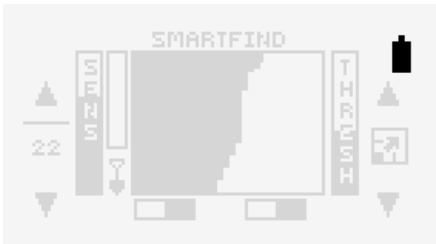

The battery life indicator appears on all of the Explorer SE detect screens.

- To extend battery life:**
- Use headphones. The speaker draws significantly more current than headphones from the battery.
 - Turn off the backlight. The backlight adds about 8% to the current consumption of the detector.
 - Turn the detector off when not in use.

	<p>The battery will be fully shaded at maximum battery charge.</p>
	<p>When the alkaline or NiMH batteries approach the point at which they do not supply enough power to operate the Explorer SE, a falling extended chord is emitted from the speaker (or headphones). When this low battery warning is heard, there will be only a few minutes of life left in the batteries.</p>
	<p>When the battery symbol is completely empty, the detector will sound an extended 'dropping' tune and display a message immediately before turning itself off.</p>

The average life-span for both good quality alkaline and NiMH rechargeable batteries under constant use is compared on the graph below. This graph assumes the backlight is turned off and headphones are being used. It is recommended that the batteries be replaced or recharged as soon as possible to avoid missing any targets. Alkaline batteries will power the Explorer SE for up to 16 hours of constant use. The NiMH 1600 battery pack will power the detector for up to 16 hours of constant use and the NiMH 1800 battery pack for 20 hours.

Unlike Nickel Cadmium batteries, the NiMH battery pack DOES NOT have to be flattened to be recharged. Whenever the detector has been unused for a lengthy period, recharge the battery pack to ensure full performance. There is no limit to the time the battery pack can be left on charge. When the battery power has been depleted, it is recommended that the batteries be replaced or recharged as soon as possible to avoid missing any targets.

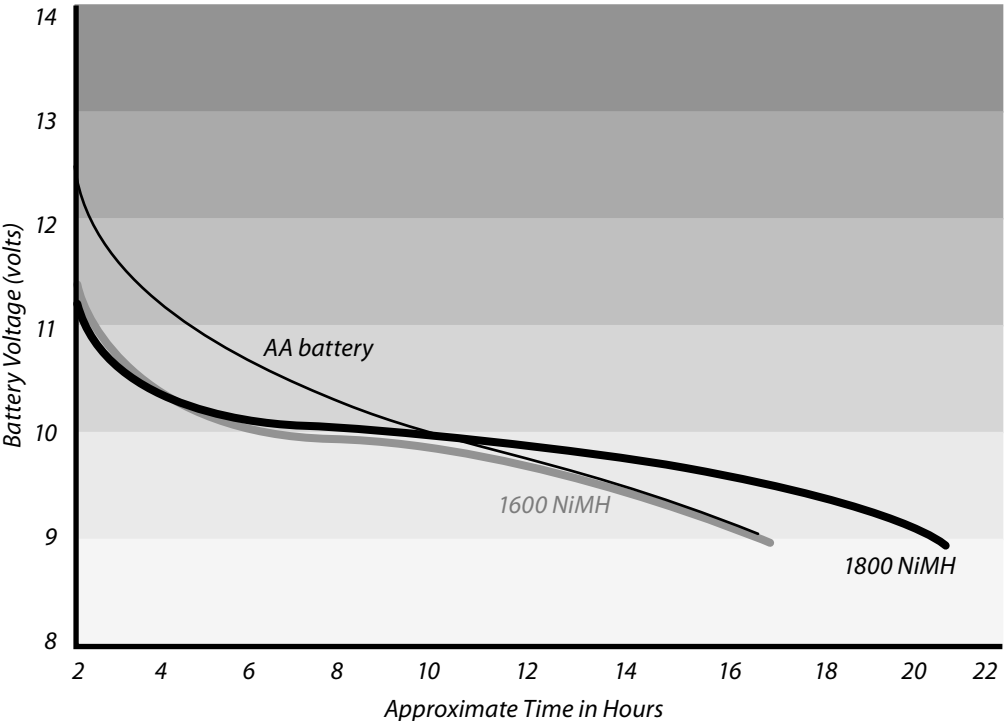

Parts and Accessories available for the Explorer SE:

- 10" Slimline FBS Coil
- 8" FBS Coil With Lower Shaft
- 10" Coil Skidplate
- 8" Coil Skidplate

- Sealed 1600mA/H NiMH Battery Pack
- Sealed 1800mA/H NiMH Battery Pack
- 'AA' Housing Battery Pack

- Mains Charger
- 12V Car Charger

- Koss UR-30 Headphones
- RPG Headphones

- Carbon Fibre Lower Shaft
- Tall Man Lower Shaft

- Armrest
- Armrest Strap with Buckles

- Coil Nut & Bolt (pk of 5)
- Coil washers (pk of 10)

- Control Box Cover
- Detector Carry Bag

- Instruction Manual

- Minelab Cap
- Minelab Polo Shirt
- Minelab Sleeveless Body Warmer
- Minelab Trash Bag

Recharging NiMH Battery Pack with the Car Charger:

- 1 Remove battery pack (pg. 10).
 - 2 Insert the car charger plug into the accessories socket of your vehicle.
 - 3 Insert the car charger plug into the socket at the tapered end of the battery pack. A small light on the car charger illuminates indicating that the car charger is in operation.
 - 4 Leave for 18 hours to fully recharge. If the battery was not completely discharged, the charging time will be shorter.
- The car charger is provided with a 3AG 2Amp fast blow fuse for short circuit protection. This can be accessed by unscrewing the tip of the accessories plug.*
- Some vehicles will need the ignition to be switched on to 'accessories' for power to be supplied to the charger.*
- Charging the battery beyond full capacity will not damage the NiMH battery pack, but it could gradually discharge your car battery.*

<i>Length Unextended</i>	<i>43 Inches (1100mm)</i>
<i>Length Extended</i>	<i>55 Inches (1358mm)</i>
<i>Shipping Weight</i>	<i>3 lb 7 oz (1700g) Excluding Batteries</i>
<i>Coil</i>	<i>10.5 inches (264mm). "Double D" Waterproof</i>
<i>Audio Output</i>	<i>Internal Speaker and Headphones</i>
<i>Headphone Input</i>	<i>1/4 Inch (6.3mm) 100 Ω Stereo Jack</i>
<i>Transmission</i>	<i>Full Band Spectrum. Simultaneous Frequency Transmission ranging from 1.5kHz –100kHz</i>
<i>Ground Rejection</i>	<i>Auto Ground Compensation – Advanced Digital Filtering</i>
<i>Discrimination</i>	<i>Smartfind™ Two-Dimensional Discrimination</i>
<i>Visual Display</i>	<i>64 x 128 Pixel Liquid Crystal Display (LCD) Control Panel</i>
<i>Batteries</i>	<i>12V</i>
<i>Patents</i>	<i>US 4890064, US 5537041, US 5506506</i>
<i>Custom Select Discrimination</i>	<i>Yes</i>
<i>Learn Function (Accept/Reject)</i>	<i>Yes</i>
<i>Saved Discrimination Patterns</i>	<i>6</i>
<i>Edit Function</i>	<i>Yes</i>
<i>Auto Noise Cancel (Scanning)</i>	<i>Yes</i>
<i>Manual Noise Cancel</i>	<i>Yes</i>
<i>User Saved Settings</i>	<i>Current, User A, User B</i>
<i>Response</i>	<i>Normal, Long, Smooth, Pitch Hold</i>
<i>Recovery</i>	<i>Selectable (Fast & Deep)</i>



The Explorer SE is a high-quality electronic instrument, finely engineered and packaged in a durable housing. Taking proper care of the detector is mostly common-sense.

Do not leave the battery pack in the Explorer SE handle when the detector is not in use for extended periods of time. Damage caused by leaking batteries could be severe and would void the warranty through user negligence.

If temperatures are very high, do not leave the detector in excessive heat for longer than necessary. Covering it when not in use will help protect it. Try to avoid leaving it in a closed car trunk or in a car sitting in sunlight. A full-length detector carry bag is available to protect the detector when in transit.

The control box has been designed to resist moisture. However, Minelab advises protecting the control box in extreme conditions. Obviously the control box should not be dropped into water. A control box cover will give protection against dust, dirt and rain.

Never allow the detector to come into contact with gasoline or other petroleum-based liquids.

Keep the detector clean and dry and avoid getting sand and grit into the shafts or fastenings (e.g. yoke bolt and camlocks). Do not use solvents to clean the detector. Use a damp cloth with mild soap detergent.

Ensure the coil cable is in good condition and not subject to undue stress.

The Explorer SE coil is only compatible with FBS technology detectors such as previous Explorers and the Quattro MP.

Flat or faulty batteries cause many detector problems. Ensure that only quality alkaline batteries are used, and that they are replaced when you hear the warning signal through the headphones or speaker.

Do not dispose of battery pack in fire (contact local authorities for disposal/recycling). Do not attempt to disassemble or short circuit the battery pack.

Take precautions when transporting or storing the detector. Although the detector is constructed from the highest quality materials and has undergone rigorous durability tests, the display screen could be prone to scratching or serious damage if not treated with due care.

Detector does not start at all	<ul style="list-style-type: none"> > Check the state of the batteries and battery connections. > Ensure battery pack lid is completely closed. > If using alkaline batteries, check whether they have been loaded in the right polarity.
Detector starts, but switches off by itself	<ul style="list-style-type: none"> > Check the state of the batteries. If necessary, try starting with batteries known to be in good condition. > Detector may be too hot. Allow detector to cool down in a shaded area. > Try starting the detector with search coil disconnected. If the detector starts normally, check the state of the coil cable. If it is damaged, replace the coil. Otherwise return detector for repairs.
No sound	<ul style="list-style-type: none"> > Unplug the headphones. If there is sound in the speaker but not in the headphones, check the headphones and their connection. > Check the AUDIO > VOLUME > MAX LIMIT (a setting of 0 is silent). > If there is no sound in the speaker or the headphones but the detector appears to work normally otherwise, return the detector for repairs.
Erratic noises	<ul style="list-style-type: none"> > Press the NOISE CANCEL shortcut button or manually select a quiet channel. > Reduce the Sensitivity. > Change the orientation of the coil to the vertical plane and rotate to see if there is a position where the noise is loudest. If this is the case, it means that there is a source of interference nearby which must be avoided. > Check battery charge and battery connections. > Ensure coil connector is tightened firmly. > Check headphones and their connection. > Check for sand or grit between coil cover and coil.
No target response	<ul style="list-style-type: none"> > Ensure the detector is turned on. > Check headphones and their connection. > Check coil connection. > Check discrimination level. No signal will be given if target is within black area of screen.

Alloy A substance which is composed of two or more metals (an alloy may also include non-metals).

Camlock Lever which releases or locks detector's assembly components. The Explorer SE's upper and lower shafts are held together by the shaft camlock. This shaft assembly is fixed to the control box by the control box camlock.

Coil The coil is the circular plate swept across the ground surface during detecting. It transmits electromagnetic signals into the ground and receives the response.

Conductivity A measure of the ability of a target to allow eddy currents induced by the transmitter.

Control Box Encloses the electronic components necessary to generate and interpret signals transmitted from the search coil and provide user access to functions via the control panel.

Control Panel This panel, which is the front of the control box, houses the display screen and provides press-button access to all of the detector's operating functions.

Digital One of Explorer SE's displays. Digital rates an object's conductivity and ferrous content as a figure between 0 and 31.

Discrimination The ability of a metal detector to identify the user's desired target and eliminate signals from undesirable objects. The Explorer SE can be programmed to discriminate against unwanted targets in either Iron Mask or Discrim.

Discrimination Pattern A two-dimensional pattern made up of shaded and clear regions of the Smartfind screen. Characteristics of a target are used to determine its position on a two-dimensional display. A Discrimination Pattern can be modified by the user to accept or reject certain targets.

Edit allows the user to customize an existing Discrimination Pattern to match preferred target characteristics.

Ferrous Composed of or containing iron. A ferrous object is one that is predominantly or completely iron. Ferrous objects (e.g. nails) are usually not desired by the detectorist.

Ferrous Content While metals are commonly divided between ferrous and non-ferrous metals, this usually refers to them being magnetic or non-magnetic. However most metals do have some ferrous content, even when classed as 'non-ferrous'.

Except for the very purest of metals, the Explorer SE is able to test the ferrous content of a metal target and use this in it's target identification.

Full Band Spectrum (FBS) Simultaneous frequency transmission ranging from 1.5 kHz to 100 kHz. This range in frequencies means that the signals received from the detector coil are analyzed from a wide range of responses.

Full Screen Target details shown on the full screen with display border and the other screen elements removed. An icon at the center right of screen switches to full screen display.

Ground Compensation The ability of the detector to compensate for the effects of ground mineralization.

Handle Assembly Part of the detector made up of the control box, handle and armrest.

Iron Mask The Iron Mask function rejects objects with ferrous properties. This level of ferrous rejection is represented with a dark 'curtain' which moves across the horizontal dimension of the Smartfind screen as the Iron Mask is adjusted.

Learn allows the user to accept or reject certain targets to create a personalized Discrimination Pattern.

Low-ferrous containing little iron. Low-ferrous objects or non-magnetic metals (such as silver or copper coins, gold jewelry, etc).

Mineralized Ground Containing certain minerals which can cause false signals to be given. Mineralized ground is handled automatically by the Explorer SE's ground compensation.

Nickel Metal Hydride (NiMH) Nickel Metal Hydride batteries are the modern equivalent of older NiCad (Nickel Cadmium) batteries. NiMH batteries have a longer life-span and are not affected by memory to the same degree.

Pinpoint Function allowing an object to be precisely located. Pinpoint overrides the automatic motion detection and discrimination settings of the Explorer SE.

Recovery allows the user to modify the way the discrimination process works and affects the audio and display responses to target characteristics.

Response The signal or audible indication of a target. Also a menu option affecting the audio response of the detector.

Sensitivity The detector's level of response to a target in the presence of ground noise and/or electromagnetic disturbance.

Shaft Assembly An adjustable assembly made up of the upper and lower shaft connected by camlocks. The shaft assembly connects the coil to the handle assembly.

Shift Buttons The three buttons at either side of the display screen. They allow selection of adjacent menu items, movement of screen slider controls and adjustment of settings.

Shortcut Buttons on the control panel offer quick access to the functions and settings most likely to be used during detector operation. **NOISE CANCEL**, **IRON MASK**, **PINPOINT** and **DETECT** are all shortcut buttons.

Slider Control Visual representation of setting adjustments for a particular function (e.g. screen contrast). Settings are adjusted with shift buttons at either side of the display screen.

Smartfind One of the Explorer SE's displays. Smartfind visually represents target details using two-dimensional discrimination.

Threshold (hum) The audible level of sound emitted when no target is detected is the Threshold. This Threshold hum is the background sound made as the Explorer SE operates. The optimum Threshold volume is a faint, but audible hum.

There is a two-year parts and labour warranty for the electronic control box of the Explorer SE. The coil has a one year parts and labour warranty. Refer to the supplier or Minelab for service, either in or out of warranty. The Minelab warranty does not cover damage caused by accident, misuse, neglect, alteration, modifications, or unauthorized service.

For specific details of the Minelab warranty, please refer to the detector's 'Product Warranty Card'.

This warranty is not transferable, nor is it valid unless the enclosed warranty registration card is returned to Minelab or your Minelab dealer within 14 days of the original purchase.

Repairs

In the unfortunate circumstance that the detector needs to be returned to Minelab for service, please fill out the Minelab Service Repair Form (or a photocopy of the same) and enclose it with the detector.

Please supply as much detail about the fault as possible. This will assist our service engineers to rectify the problem quickly and efficiently.

Today's Date

Detector / Model

Serial Number

Purchased From

Purchase Date

Faulty Part(s)

Owner's Name

Address

Telephone () Day Home

Fax ()

Email

Description of Fault

Please explain how we can replicate the problem in order to fix your detector.

.....
.....
.....
.....
.....
.....
.....
.....
.....
.....
.....
.....
.....
.....
.....
.....
.....
.....
.....
.....
.....
.....

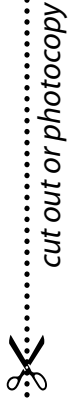

Minelab Electronics Pty Ltd

PO Box 537, Torrensville Plaza
Adelaide, South Australia, 5031

Australia

Tel: 61-8-8238 0888
Fax: 61-8-8238 0890
Email: minelab@minelab.com.au

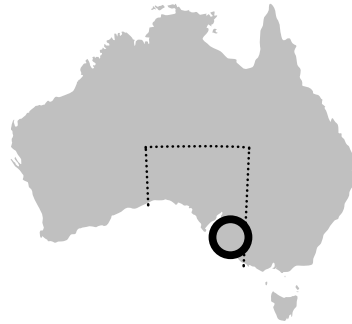

Minelab International Ltd

Laragh, Bandon
Co. Cork

Ireland

Tel: 353 23 52 101
Fax: 353 23 52 106
Email: minelab@minelab.ie



Minelab USA Inc

871 Grier Drive, Suite B1
Las Vegas, Nevada, 89119

USA

Tel: 1 702 891 8809
Fax: 1 702 891 8810
Email: minelab@minelabusa.com

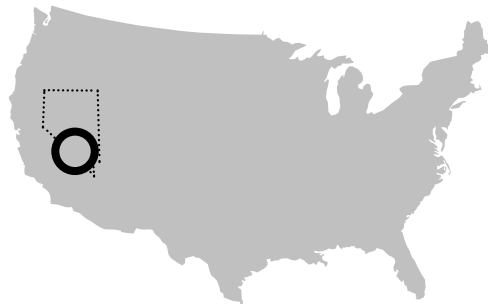

For further product information
and detecting tips, refer to:

WWW.MINELAB.COM

© Minelab Electronics Pty Ltd

This document contains proprietary information which is protected by copyright. Apart from any use as permitted under the Copyright Act 1968, no part may be reproduced by any process without written permission from Minelab Electronics Pty Ltd, 118 Hayward Avenue, Torrensville, SA 5031, Australia.

WARNING. This document contains Minelab Electronics Pty Ltd rights, technical data or restricted rights data, or both. Patents and trademarks apply.



For Consumers within the European Union:
Do not dispose of this equipment in general household waste.

The crossed out wheeled bin indicated on this equipment is an indicator that this unit should not be disposed of in general household waste, but recycled in compliance with local government regulations or environmental requirements.

Please dispose of this equipment via a recycling service or centre, or by returning the unit to the respective Minelab or Halcro outlet as appropriate for your unit. This will enable the equipment to be disposed of in an environmentally safe manner.

Disposal of unwanted electronic equipment in landfilled waste may contribute to adverse long term environmental effect due to the leaching of contaminating and toxic substances contained within some electronic equipment.

Disclaimer:

The Minelab metal detector discussed in this operating manual has been expressly designed and manufactured as a quality hobbyist metal detector and is recommended for use in coin, treasure and general metal detection in non-hazardous environments. This metal detector has not been designed for use as a mine detector or as a live munitions detection tool.

Please note:

Since there may be a variety of options available for this detector, equipment may vary according to the Model or items ordered with your detector. Certain descriptions and illustrations may also differ (in this manual) from the exact Model that you purchased. In addition, Minelab reserves the right to respond to ongoing technical progress by introducing changes in design, equipment and technical features at any time.

THIS DEVICE COMPLIES WITH PART 15 OF THE FCC RULES

Operation is subject to the following two conditions: (1) this device may not cause harmful interference, and (2) this device must accept any interference received, including interference that may cause undesired operation.



Item Number: 4901 - 0061
Revision: 1.1